



2023 PRODUCT GUIDE



Ningbo Topoint Precision Machinery Co.,Ltd.

TEL: +86-574-86109226

FAX: +86-574-86109225

M.T: +86-013906695650 / 013958310671

Website: <http://www.china-topoint.com>

Facebook: <https://www.facebook.com/pages/Topoint-Archery/663601533684768>

Address: No.66,Road 2,LongTanShan ,Daqi Town,Beilun District,Ningbo 315806,Zhejiang,China

Wechat:13906695650

Whatsapp:13906695650

Email: sales@china-topoint.com





Topoint Archery are professional archery product manufacturerin Ningbo China,we produce compound bow,bow sight,arrow rest, arrow quiver,bow stabilizer,bow release,archery arrow,broadheads, archery upgrade combo,bow sling etc.

Topoint Archery have CNC machining center,CNC lathe,Assembly line,Automatic Bow press, bowstring weaving equipment,automatic arrow vanes paste,etc work shop for manufacture archery product.

In 2011 years,we create own brand "TOPOINT ARCHERY",well sale in world archery market to hunter,Topoint Archery will provide new archery product in every years.

**Wholesale and OEM/ODM are available in Topoint Archery
Lowest Price! High Quality! Timely Delivery!**

MANUFACTURING TECHNIQUE

Topoint Archery are professional archery product manufacturerin Ningbo China,we produce compound bow,bow sight,arrow rest, arrow quiver,bow stabilizer,bow release,archery arrow,broadheads, archery upgrade combo,bow sling etc. Topoint Archery have CNC machining center,CNC lathe,Assembly line,Automatic Bow press, bowstring weaving equipment,automatic arrow vanes paste,etc work shop for manufacture archery product.



CONTENTS

Compound bows.....	01
Archery upgrade combo.....	45
Bow Sights Series.....	47
Arrow Rests.....	57
Long rod stabilizers.....	61
Bow Stabilizers Series.....	69
Bow Releases.....	73
Arrow Quivers.....	79
Bow Tuning.....	83
Braided Bow Slings.....	84
Bow Cases.....	85
Peep Sights.....	89
Archery Accessories.....	91
Bow Fishing.....	94
Arrows.....	95
Broadheads.....	97
Recurve Bows.....	99
Recurve Bow Sights Series.....	125
Recurve Arrow Rests.....	129
Recurve Bow Accessories.....	131
Hunting Clothings.....	136

www.china-topoint.com
www.daibow.com
sales@topoint-archer.com



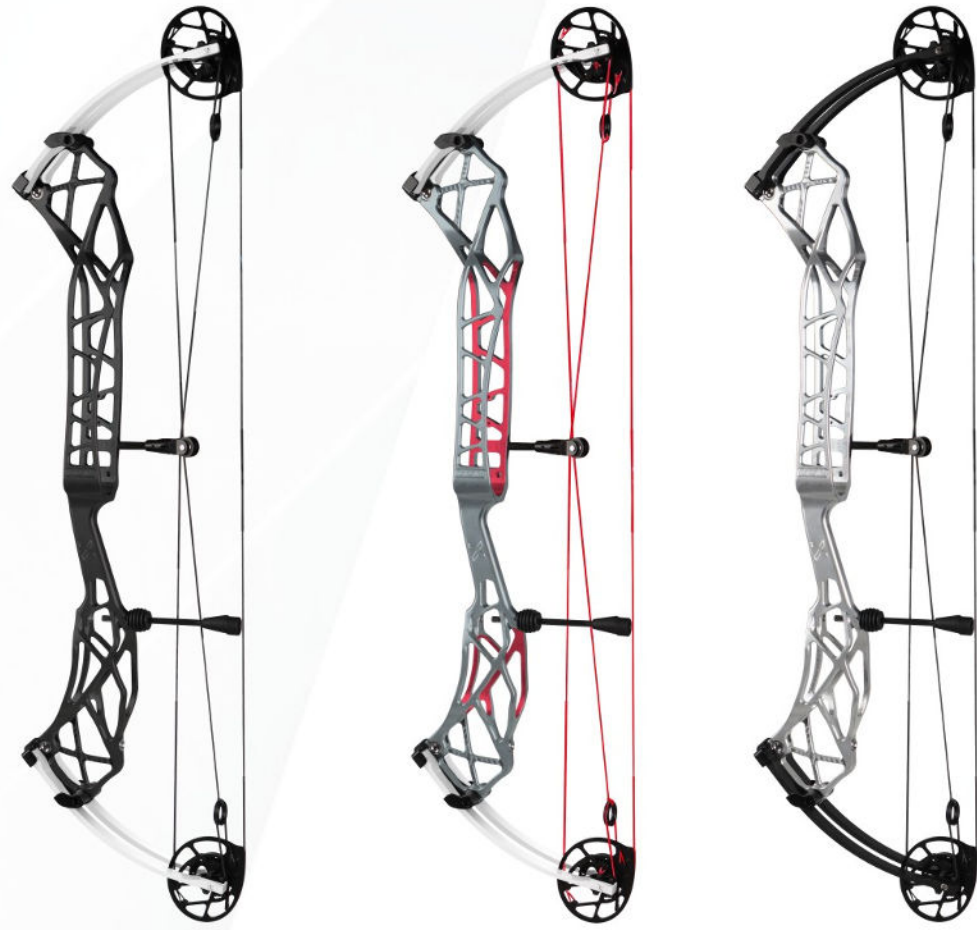

Black ▲

Smoke/Red ▲

Silver ▲

TOPOINT BRETH X40 SPECS

	Dual/Adjustable (CAM1)	Dual/Adjustable (CAM2)
Cam	Dual/Adjustable (CAM1)	Dual/Adjustable (CAM2)
IBO Rate	Up to 330 fps	Up to 330 fps
Physical Weight	4.85 lbs.	4.76 lbs.
Axle to Axle	40"	40"
Brace Height	7"	6.75"
Let-off	75%	75%
Draw Weight	50 , 60lbs	50, 60lbs
Riser	Aluminum CNC Machining	Aluminum CNC Machining
Finish	Anodized	Anodized
Draw Length(CAM1)	27-31",without Bow press	25-28",without Bow press
Bowstrings	BCY	BCY
String Length	63.58"	58.66"
Cable Length	38.74" X 2	38.5" X 2
Grip	Aluminum	Aluminum



ALUMINUM 6061-T651(Double Color)

COMPOUND BOW TOPOINT X40

- Bow limb import form Gordon Composites In USA special limb supplier
- CNC machining bow riser, material: 6061-T6
- CNC machining bow cam, material: 7075-T6
- Surface finish: Anodized ,10color select
- Bow string use BCY material
- Draw Length: 25-31" Adjsutable, without bow press
- Draw weight: 50lbs/60lbs
- Right Hand /Left Hand Available

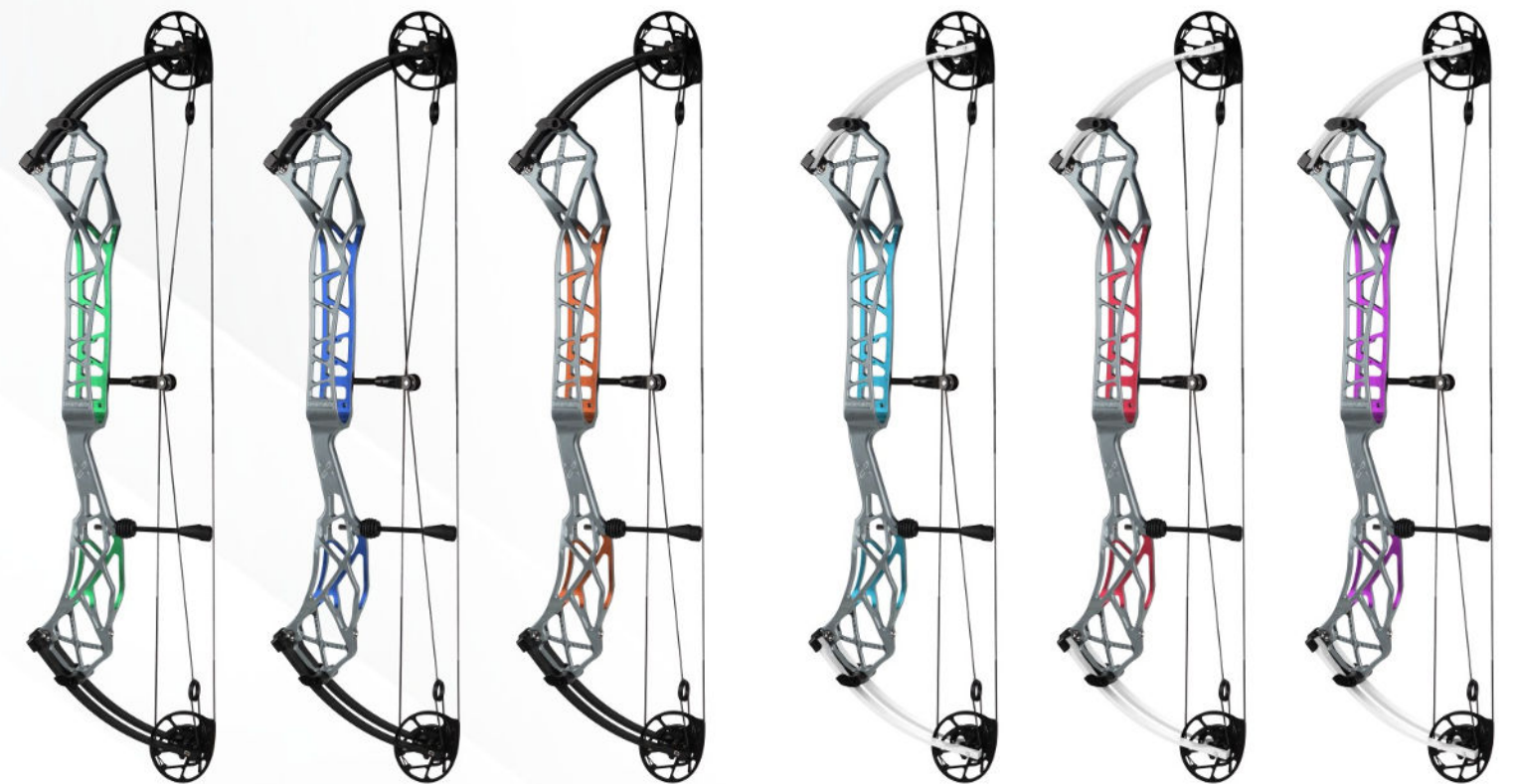

Smoke/Green ▲

Smoke/Blue ▲

Smoke/Orange ▲

Smoke/Turquoise ▲

Smoke/Red ▲

Smoke/Purple ▲

TOPPOINT X 40 CUSTOMIZABLE

BOWLIMB/BOWRISER/ANDBOW STRING COLORS



Purple ▲



Red ▲



Black ▲



Green ▲



Orange ▲



Purple ▲



Blue ▲



Pink ▲



Turquoise ▲



Smoke ▲



TOPOINT RELIANCE 36

RIGHT HAND Only



COMPOUND BOW RELIANCE 36

- Bow limb import form Gordon Composites In USA special limb supplier
- CNC machining bow riser, material : 6061-T6
- CNC machining bow cam, material: 7075-T6
- Surface finish: Anodized ,9color select
- Bow string use BCY material
- Draw Length: 24-29.5" adjsutable, without bow press
- Draw weight: 40lbs/50lbs/ 60lbs



Red ▲ Black ▲



Blue ▲ Smoke ▲ Pink ▲ Turquoise ▲ Orange ▲ Green ▲

TOPOINT RELIANCE 36 SPECS

	Dual/Adjustable (CAM1)	Dual/Adjustable (CAM2)
Cam	Dual/Adjustable (CAM1)	Dual/Adjustable (CAM2)
IBO Rate	Up to 330 fps	Up to 330 fps
Physical Weight	4.57 lbs	4.31 lbs
Axle to Axle	36"	36"
Brace Height	7"	6.75"
Let-off	75%	75%
Draw Weight	40, 50 , 60lbs	40, 50, 60lbs
Riser	Aluminum CNC Machining	Aluminum CNC Machining
Finish	Anodized	Anodized
Draw Length(CAM1)	26.5-29.5",without Bow press	24-27",without Bow press
Bowstrings	BCY	BCY
String Length	59.7"	55.1"
Cable Length	35" X 2	35" X 2
Grip	Aluminum	Aluminum



The CAM system

The Cam designed by the famous compound bow designer in China, this cam system can adjust the draw length without bow press, 2 kinds of different draw length Cams can be selected this can fit almost all different draw lengths' players. High speed design can help you increase shooting consistency and accuracy.



GRIP SYSTEM

CNC milling technique make the grip more stronger. Special angle design of the grip help you increase shooting consistency and accuracy.



The Limbs

The limbs are imported from USA produced by Gordon Composites ,the most popular limb supplier in the world. The 18mm width limbs make the bow more stronger, meanwhile these limbs can help the bow perform better in daily use.

RELIANCE

TARGET COMPOUND BOW

36"

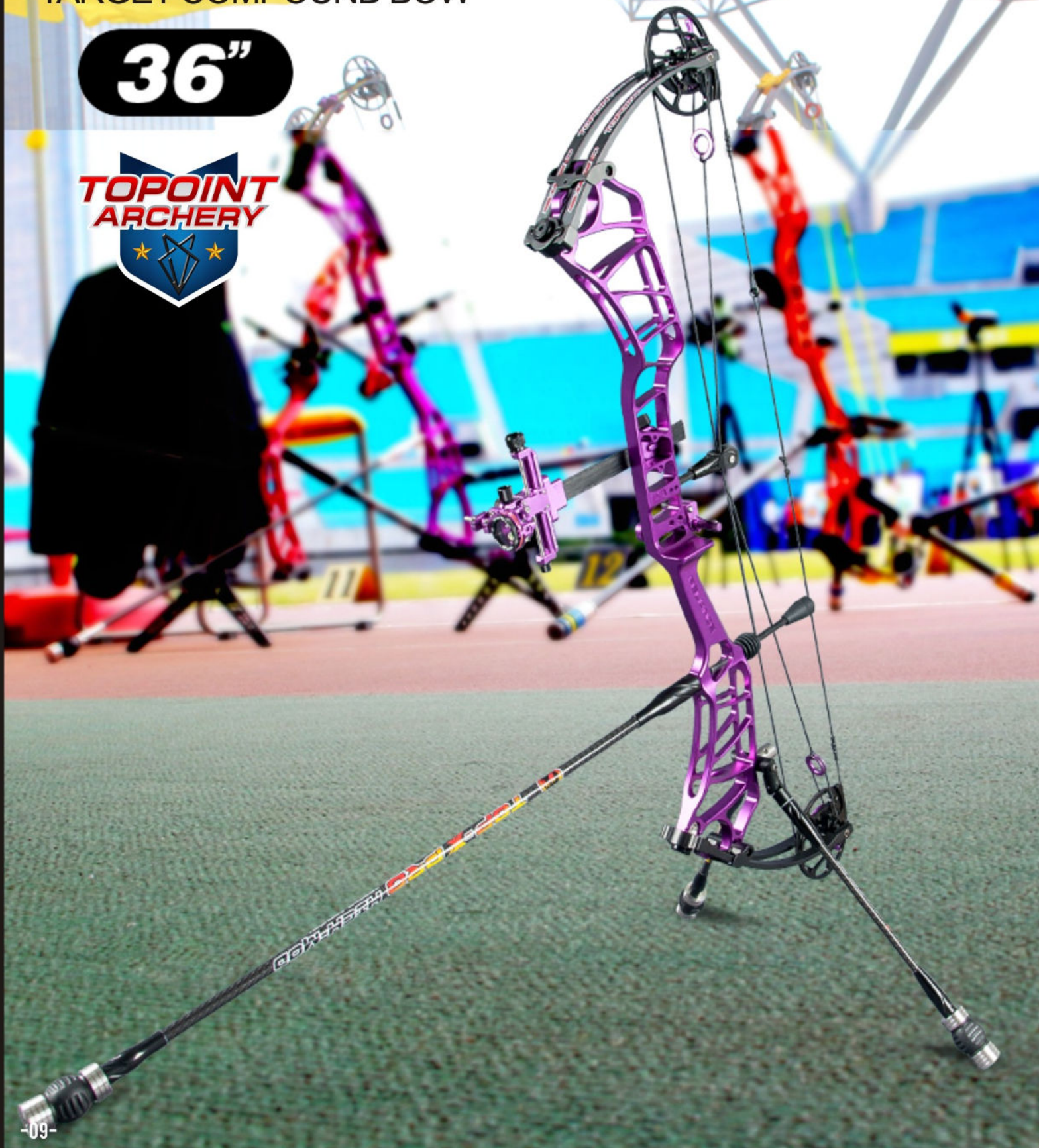

PACKAGE LIST

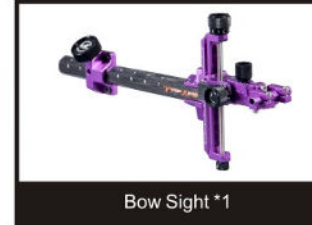

Bow Sight *1



Bow Sight Scope With Lens *1



Double Adjustable V-BAR mount *1

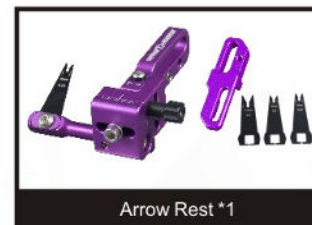

Arrow Rest *1



Pro Series Peep *1



Quick Discount Bolt *3

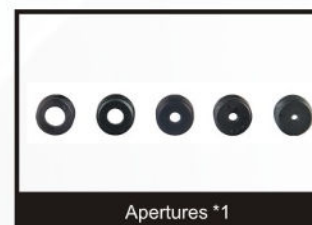

Apertures *1

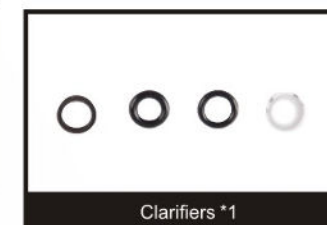

Clarifiers *1



Stabilizer Bomb *3



Single Weight *3



Double Weight *3



Four Weight *3



TOP-X Pro Long Rod Stabilizer
PR651 MAIN 30" *1
PR651 SIDE 12" *2

COMPOUND BOW RELIANCE 36 COMBO

- Compound Bow Reliance *1
- Bow Sight *1
- Bow Sight Scope With Lens *1
- Arrow Rest *1
- Pro Series Peep *1
- Apertures(1/8" 3/32" 1/16" 1/32") *1
- Clarifiers *1
- TOP-X Pro Long Rod Stabilizer PR651 MAIN 30" *1 PR651 SIDE 12" *2
- Double Adjustable V-BAR mount *1
- Quick Discount Bolt *3
- Stabilizer Bomb *3
- Single Weight *3
- Double Weight *3
- Four Weight *3

TOPOINT RELIANCE 38

Right Hand /Left Hand Available



COMPOUND BOW RELIANCE 38

- Bow limb import form Gordon Composites In USA special limb supplier
- CNC machining bow riser, material : 6061-T6
- CNC machining bow cam, material: 7075-T6
- Surface finish: Anodized ,8color select
- Bow string use BCY material
- Draw Length: 24.5-30.5" adjustable, without bow press
- Draw weight: 50lbs/ 60lbs
- Right Hand /Left Hand Available



Red ▲ Black ▲



Blue ▲ Smoke ▲ Purple ▲ Turquoise ▲ Orange ▲ Green ▲

TOPOINT RELIANCE 38 SPECS

	Dual/Adjustable (CAM1)	Dual/Adjustable (CAM2)
Cam	Dual/Adjustable (CAM1)	Dual/Adjustable (CAM2)
IBO Rate	Up to 330 fps	Up to 330 fps
Physical Weight	4.76 lbs.	4.67 lbs.
Axle to Axle	38"	38"
Brace Height	7.5"	7.3"
Let-off	75%	75%
Draw Weight	50 , 60lbs	50, 60lbs
Riser	Aluminum CNC Machining	Aluminum CNC Machining
Finish	Anodized	Anodized
Draw Length(CAM1)	26.5-30.5",without Bow press	24.5-27.5",without Bow press
Bowstrings	BCY	BCY
String Length	61.8"	57"
Cable Length	36.8" X 2	36.8" X 2
Grip	Aluminum	Aluminum



The CAM system

The Cam designed by the famous compound bow designer in China, this cam system can adjust the draw length without bow press, 2 kinds of different draw length Cams can be selected this can fit almost all different draw lengths' players. High speed design can help you increase shooting consistency and accuracy.



GRIP SYSTEM

CNC milling technique make the grip more stronger. Special angle design of the grip help you increase shooting consistency and accuracy.



The Limbs

The limbs are imported from USA produced by Gordon Composites, the most popular limb supplier in the world. The 18mm width limbs make the bow more stronger, meanwhile these limbs can help the bow perform better in daily use.

TARGET COMPOUND BOW

TOPOINT RELIANCE 36/38



Green&Blue



Green&Pink



Pink&Blue



Pink&White



Blue&White



Green&White



Chameleon



Electroplating Gold



Electroplating Titanium



Electroplating Silver



RELIANCE

TARGET COMPOUND BOW



PACKAGE LIST

COMPOUND BOW RELIANCE 38 COMBO

- Compound Bow Reliance *1
- Bow Sight *1
- Bow Sight Scope With Lens *1
- Arrow Rest *1
- Pro Series Peep *1
- Apertures(1/8" 3/32" 1/16" 1/32") *1
- Clarifiers *1
- TOP-X Pro Long Rod Stabilizer PR651 MAIN 30" *1 PR651 SIDE 12" *2
- Double Adjustable V-BAR mount *1
- Quick Discount Bolt *3
- Stabilizer Bomb *3
- Single Weight *3
- Double Weight *3
- Four Weight *3

TARGET COMPOUND BOW

DAIBOW STRONGHOLD

RIGHT HAND Only



COMPOUND BOW STRONGHOLD

- Bow limb import form Gordon Composites In USA special limb supplier
- CNC machining bow riser,material: 6061-T6
- CNC machining bow cam,material: 7075-T6
- Surface finish: Anodized ,8color select
- Bow string use BCY material
- Draw Length: 24.5-30.5" adjsutable, without bow press
- Draw weight: 50lbs /60lbs



Electroplating Gold ▲ Electroplating Titanium ▲ Electroplating Silver ▲



Black ▲ Smoke ▲ Red ▲ Orange ▲ Green ▲ Turquoise ▲ Blue ▲ Purple ▲

DAIBOW STRONGHOLD SPECS

	Dual/Adjustable (CAM1)	Dual/Adjustable (CAM2)
Cam	Dual/Adjustable (CAM1)	Dual/Adjustable (CAM2)
IBO Rate	Up to 330 fps	Up to 330 fps
Physical Weight	4.76 lbs.	4.67 lbs.
Axle to Axle	38"	38"
Brace Height	7.5"	7.3"
Let-off	75%	75%
Draw Weight	50 , 60lbs	50, 60lbs
Riser	Aluminum CNC Machining	Aluminum CNC Machining
Finish	Anodized	Anodized
Draw Length(CAM1)	26.5-30.5",without Bow press	24.5-27.5",without Bow press
Bowstrings	BCY	BCY
String Length	61.8"	57"
Cable Length	36.8" X 2	36.8" X 2
Grip	Aluminum	Aluminum



The CAM system

The Cam designed by the famous compound bow designer in China, this cam system can adjust the draw length without bow press,2 kinds of different draw length Cams can be selected this can fit almost all different draw lengths' players. Hight speed design can help you increase shooting consistency and accuracy.



GRIP SYSTEM

CNC milling technique make the grip more stronger. Special angle design of the grip help you increase shooting consistency and accuracy.



The Limbs













The limbs are imported from USA produced by Gordon Composites ,the most popular limb supplier in the world. The 18mm width limbs make the bow more stronger, meanwhile these limbs can help the bow perform better in daily use.

STRONGHOLD

TARGET COMPOUND BOW



PACKAGE LIST

			
Bow Sight *1	Bow Sight Scope With Lens *1	Double Adjustable V-BAR mount *1	
			
Arrow Rest *1	Pro Series Peep *1	Quick Discount Bolt *3	
			TOP-X Pro Long Rod Stabilizer PR651 MAIN 30" *1 PR651 SIDE 12" *2
Apertures *1	Clarifiers *1	Stabilizer Bomb *3	
			
Single Weight *3	Double Weight *3	Four Weight *3	

COMPOUND BOW STRONGHOLD COMBO

- Compound Bow Stronghold* 1
- Bow Sight *1
- Bow Sight Scope With Lens*1
- Arrow Rest *1
- Pro Series Peep *1
- Apertures(1/8" 3/32" 1/16" 1/32") *1
- Clarifier *1
- TOP-X Pro Long Rod Stabilizer PR651 MAIN 30" *1 PR651 SIDE 12" *2
- Double Adjustable V-BAR mount *1
- Quick Discount Bolt *3
- Stabilizer Bomb *3
- Single Weight *3
- Double Weight *3
- Four Weight *3

TARGET COMPOUND BOW

TOPOINT BRETH 36

Right Hand /Left Hand Available

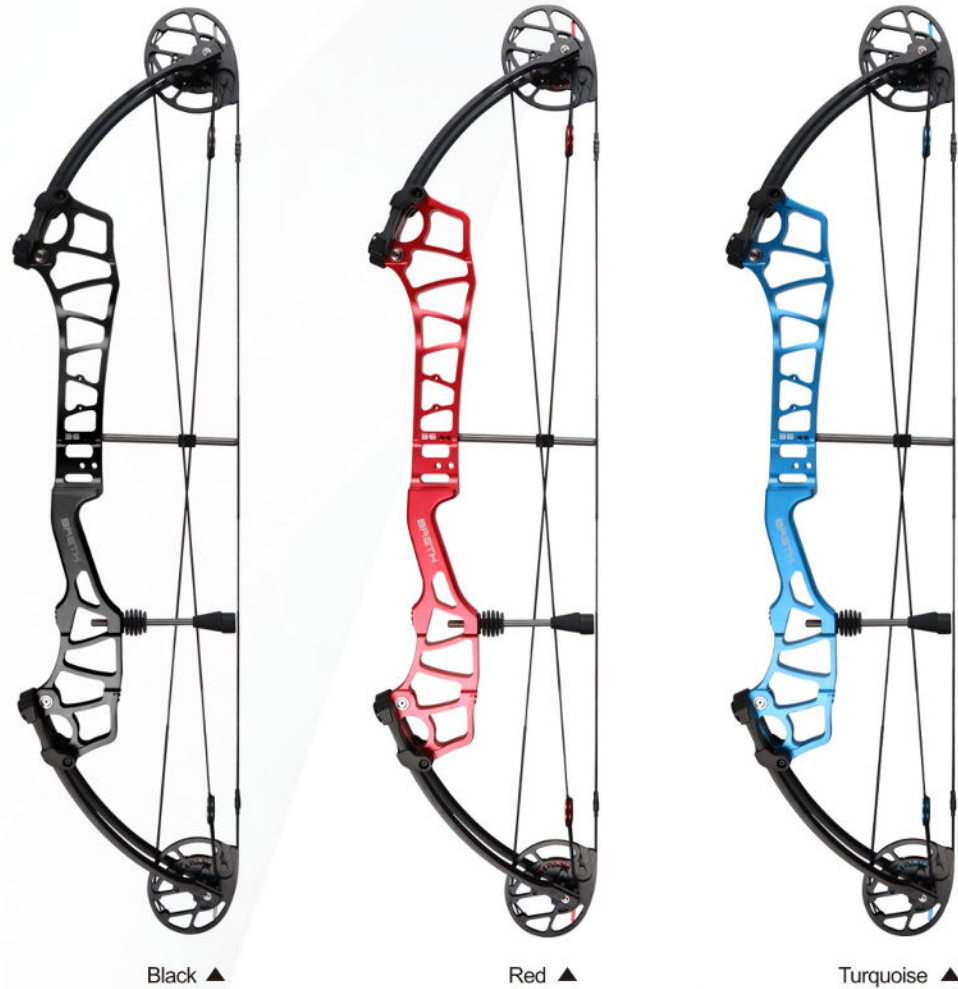

Black ▲

Red ▲

Turquoise ▲

TOPOINT BRETH 36 SPECS

	Dual/Adjustable (CAM1)	Dual/Adjustable (CAM2)
Cam	Dual/Adjustable (CAM1)	Dual/Adjustable (CAM2)
IBO Rate	Up to 330 fps	Up to 330 fps
Physical Weight	4.27 lbs.	4.18 lbs.
Axle to Axle	36"	36"
Brace Height	7"	6.75"
Let-off	75%	75%
Draw Weight	40, 50, 60lbs	40, 50, 60lbs
Riser	Aluminum CNC Machining	Aluminum CNC Machining
Finish	Anodized	Anodized
Draw Length(CAM1)	26-30",without Bow press	24-27",without Bow press
Bowstrings	BCY	BCY
String Length	59.5"	54.9"
Cable Length	35" X 2	35" X 2
Grip	Aluminum	Aluminum



Ghost ▲

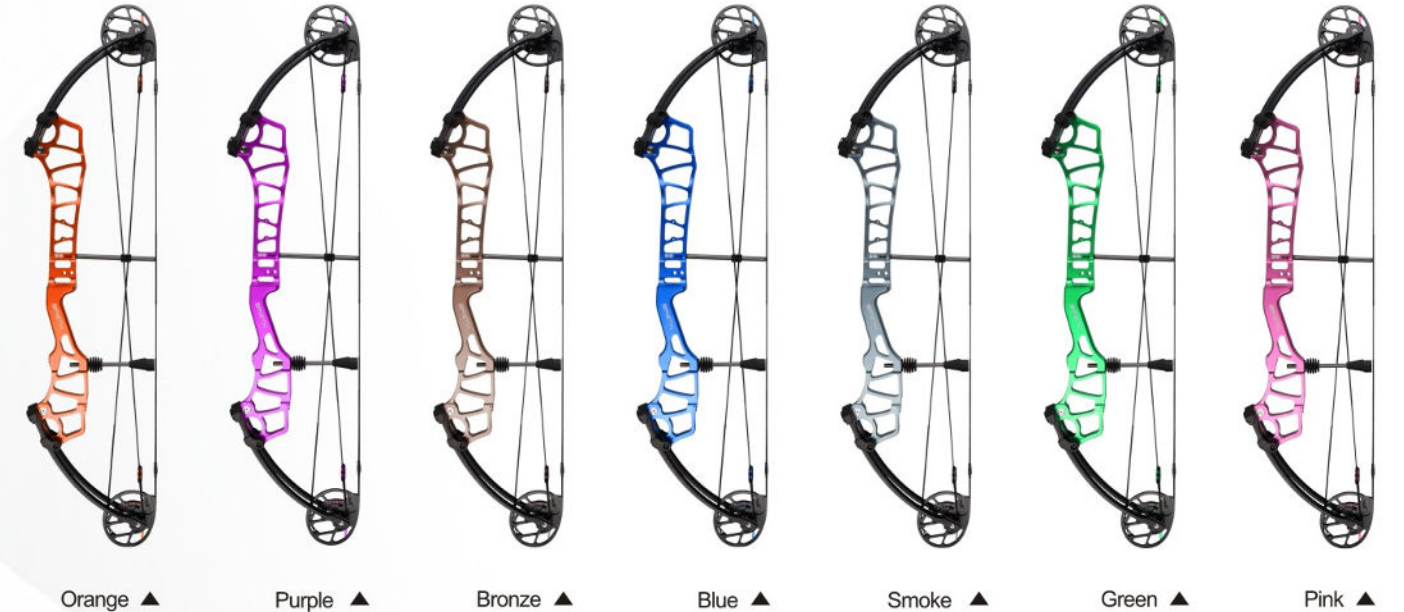

Orange ▲

Purple ▲

Bronze ▲

Blue ▲

Smoke ▲

Green ▲

Pink ▲

COMPOUND BOW BRETH 36

Bow limb import form Gordon Composites In USA special limb supplier

- CNC machining bow riser, material: 6061-T6
- CNC machining bow cam, material: 7075-T6
- Surface finish: Anodized ,10color select
- Bow string use BCY material
- Draw Length: 24-30" Adjsutable, without bow press
- Draw weight: 40lbs/ 50lbs/60lbs
- Right Hand /Left Hand Available



The CAM system

The Cam designed by the famous compound bow designer in China, this cam system can adjust the draw length without bow press.2 kinds of different draw length Cams can be selected this can fit almost all different draw lengths' players. High speed design can help you increase shooting consistency and accuracy.

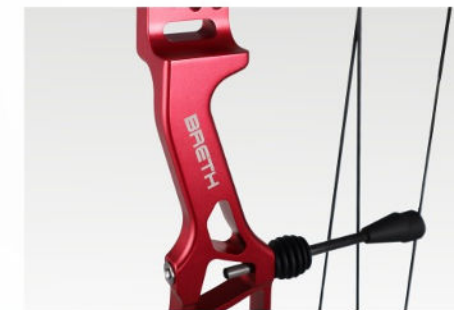

GRIP SYSTEM

CNC milling technique make the grip more stronger. Special angle design of the grip help you increase shooting consistency and accuracy.



The Limbs

The limbs are imported from USA produced by Gordon Composites ,the most popular limb supplier in the world. The 18mm width limbs make the bow more stronger, meanwhile these limbs can help the bow perform better in daily use.

HUNTING COMPOUND BOW

DAIBOW ACUITY

RIGHT HAND Only



Black ▲



Ghost ▲



Camo ▲



Muddy Black ▲



Skullworks ▲

IBO Rate	Up to 350 fps	Finished	Anodized /Camo
CAM	Dual /Adjustable	Draw Length	26-30", without bow press
Physical Weight	4.22 lbs	Bowstring	BCY
Axle To Axle	28"	String Length	56.3"
Brace Height	6"	Cable Length	27.63" X 2
Let-Off	75%	Bow Grip	Aluminum
Draw Weight	50,60,70lbs	Color	Black /Ghost /Skullworks camo /Camo /Muddy black
Bow Riser	Aluminum 6061-T6 CNC Milling		

HUNTING COMPOUND BOW

DAIBOW VIGOR

RIGHT HAND Only



Muddy Black ▲



Ghost ▲

Camo ▲

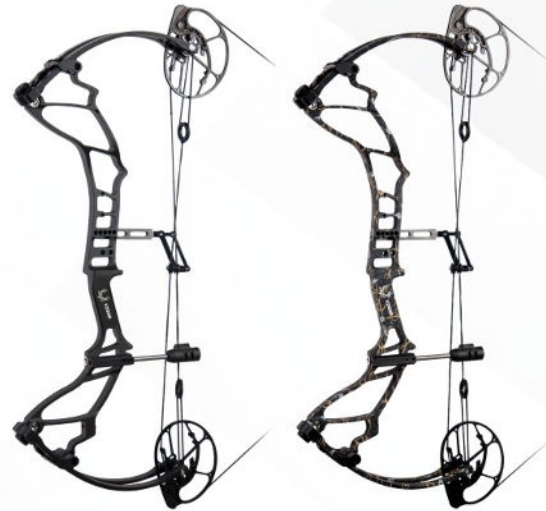

Black ▲

Skullworks ▲

IBO Rate	Up to 350 fps	Finished	Anodized /Camo
CAM	Dual /Adjustable	Draw Length	26.5-30.5",without bow press
Physical Weight	4.63 lbs	Bowstring	BCY
Axle To Axle	29.5"	String Length	57.8"
Brace Height	6"	Cable Length	28.7" X 2
Let-Off	75%	Bow Grip	Aluminum
Draw Weight	50,60,70lbs	Color	Black /Ghost /Skullworks camo /Camo /Muddy black
Bow Riser	Aluminum 6061-T6 CNC Milling		





HUNTING COMPOUND BOW

DAIBOW TACHYON

RIGHT HAND Only



Camo ▲



Ghost ▲

Black ▲



Muddy Black ▲

Skullworks ▲

IBO Rate	Up to 350 fps	Finished	Anodized /Camo
CAM	Dual /Adjustable	Draw Length	26.5-30.5", without bow press
Physical Weight	4.38 lbs	Bowstring	BCY
Axle To Axle	31"	String Length	58.86"
Brace Height	6"	Cable Length	29.13" X 2
Let-Off	75%	Bow Grip	Aluminum
Draw Weight	50,60,70lbs	Color	Black/ Ghost/ Skullworks camo / Camo/ Muddy black
Bow Riser	Aluminum 6061-T6 CNC Milling		

HUNTING COMPOUND BOW

DAIBOW MOMENTOUS

RIGHT HAND Only



Black ▲



Ghost ▲

Camo ▲



Muddy Girl ▲

Snow Camo ▲

IBO Rate	Up to 320 fps	Finished	Anodized /Camo
CAM	Dual /Adjustable	Draw Length	19-30", without bow press
Physical Weight	3.91lbs	Bowstring	BCY
Axle To Axle	31"	String Length	58.75"
Brace Height	7"	Cable Length	33.938" X 2
Let-Off	80%	Bow Grip	Aluminum
Draw Weight	19-70 lbs	Color	Black /Ghost /Camo Muddy black
Bow Riser	Aluminum CNC Milling		





Information	
Item Name	T1
IBO Rate	Up to 320 fps
Physical Weight	3.8 lbs
Axle To Axle	31"
Brace Height	7"
Let-Off	75%
Draw Weight	19-70lbs, adjustable
Bow Riser	Aluminum CNC Milling
Surface Finished	Anodized / Camo
Draw Length	19-30", without bow press every 0.5" adjustable
Bow Cam	Dual/Adjustable, With 2 Bearings
Bowstring Material	BCY
String Length	58.75"
Cable Length	33.938" X 2
Grip	Aluminum

COMPOUND BOW T1

Right Hand /Left Hand Available

- CNC machining bow riser, material: 6061-T6
- CNC machining bow cam
- Bow string use BCY material
- Draw Length: 19-30", every 0.5" adjustable, without bow press
- Draw Weight: 19-70lbs
- Surface finish: Anodized or camo water transfer, 13color select
- Bow limb import form Gordon Composites In USA special limb supplier



Black ▲

Army green ▲

Ghost ▲

Camo ▲



Pink ▲

Orange ▲

Purple ▲

Red ▲

MATT Black ▲

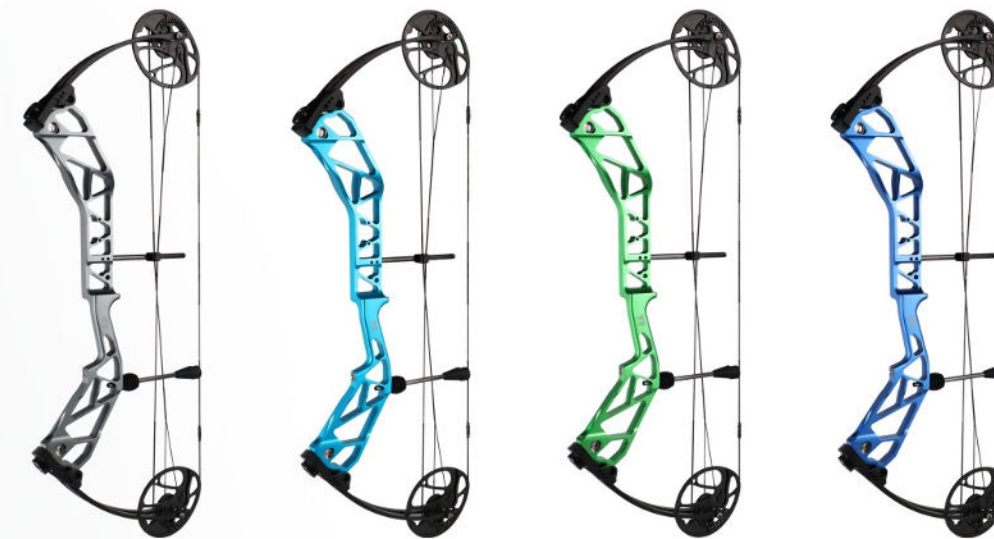

Smoke ▲

Turquoise ▲

Green ▲

Blue ▲

PACKAGE SELECTION

Basic Package For Bowhunting

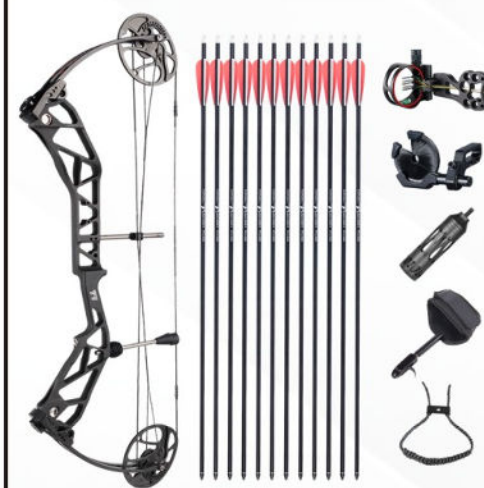

Delux Package For Bowhunting

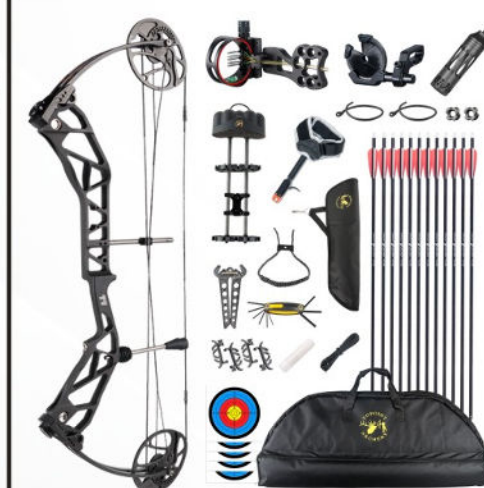

Target package for competitive





Information	
Item Name	M1
IBO Rate	320 fps
Physical Weight	3.31 lbs
Axle To Axle	28"
Brace Height	7"
Let-Off	80%
Draw Weight	19-70lbs
Bow Riser	Aluminum
Surface Finished	Water Transfer, Anodized
Draw Length	19-30", without bow press
Bowstring Material	BCY-X
String Length	55.55"
Cable Length	30.78" X 2
Bow Grip	Aluminum

COMPOUND BOW M1

RIGHT HAND Only

- Aluminum Alloy bow riser
- Bow string use BCY material
- Draw weight: 19-70lbs
- Bow limb import form Gordon Composites In USA special limb supplier
- CNC machining bow cam, material: 7075-T6
- Draw Length: 19-30" adjustable, without bow press
- Surface finish: anodized or camo water transfer, 6 color select



Snow-Camo ▲ Muddy girl ▲ Ghost ▲ Camo ▲ Black ▲ Smoke ▲



Junior Compound Bow

TOPPOINT M2

RIGHT HAND Only



Camo ▲

Pink ▲

IBO Rate	Up to 290 fps	Finished	Powder-coated /Camo
CAM	Dual /Adjustable	Draw Length	17-27", without bow press
Physical Weight	2.54lbs	Bows Limbs	Gordon Composites
Axle To Axle	25"	String Length	49.13"
Brace Height	6.8"	Cable Length	27.95" X 2
Let-Off	75%	Bow Grip	Aluminum
Draw Weight	10-40lbs, adjustable	Color	Black /Blue /Camo /Muddy girl
Bow Riser	Aluminum		Purple /Pink /Green

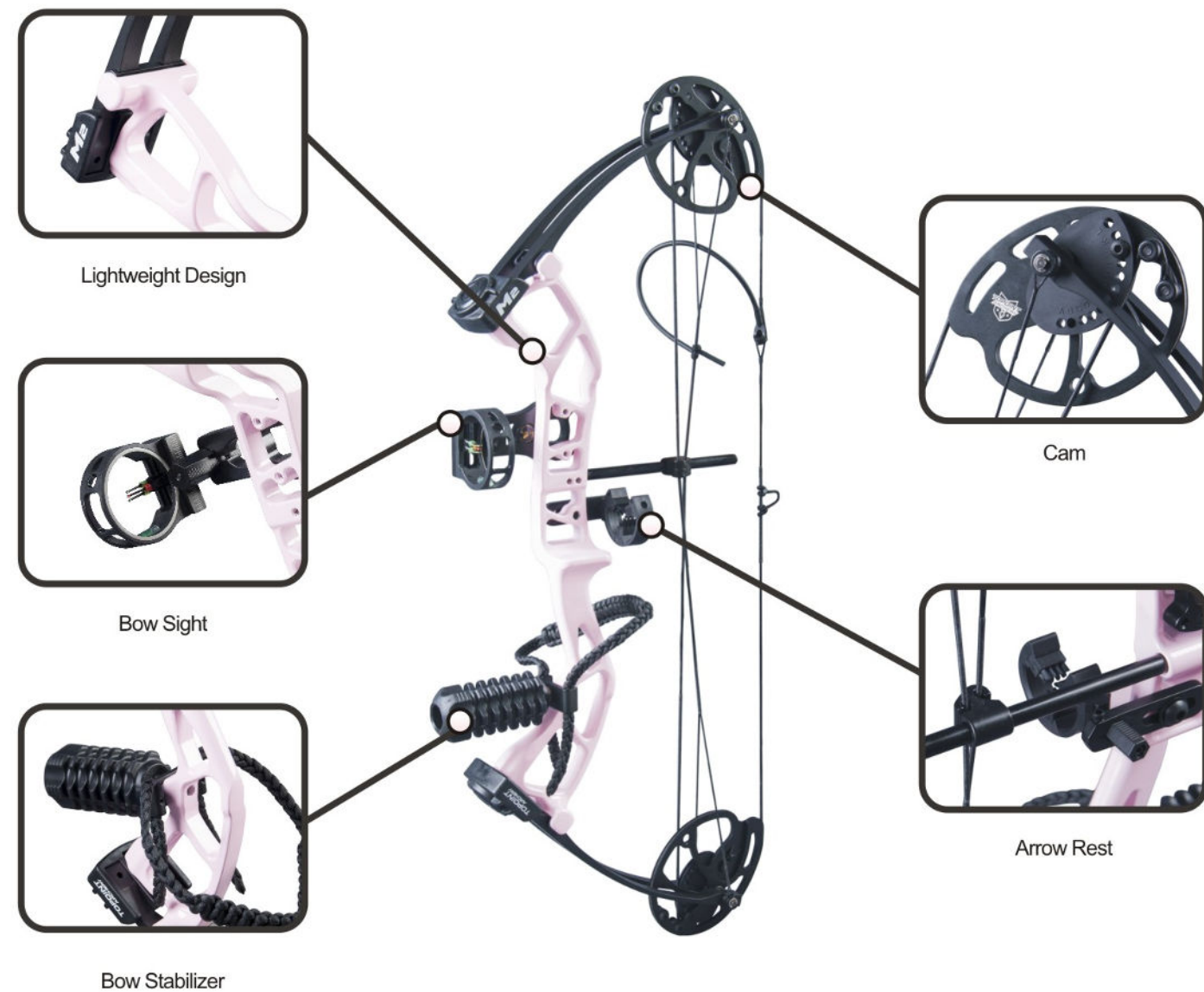

Lightweight Design

Bow Sight

Bow Stabilizer

Cam

Arrow Rest

COLOR OPTION

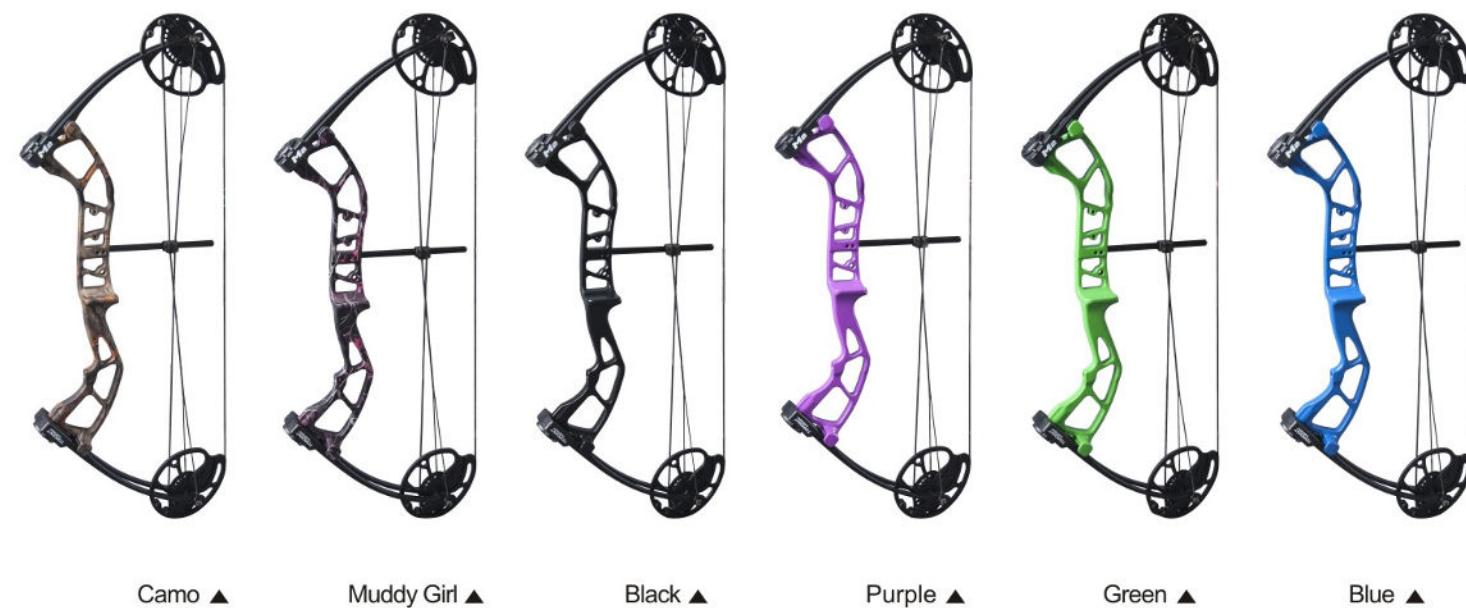

Camo ▲

Muddy Girl ▲

Black ▲

Purple ▲

Green ▲

Blue ▲

Junior Compound Bow TOPPOINT M3

Right Hand /Left Hand Available



Camo ▲

Blue ▲

IBO Rate	Up to 260 fps	Finished	Material base color/ Camo
CAM	Dual /Adjustable	Draw Length	17-27", without bow press
Physical Weight	2.54lbs	Bows Limbs	PA+ 30%GF
Axle To Axle	26"	String Length	48.6"
Brace Height	6.5"	Cable Length	28.74" X 2
Let-Off	75%	Color	Black /Blue /Camo /Muddy girl Purple /Red /Green
Draw Weight	10 - 30lbs, adjustable		
Bow Riser	PA+ 30%GF		

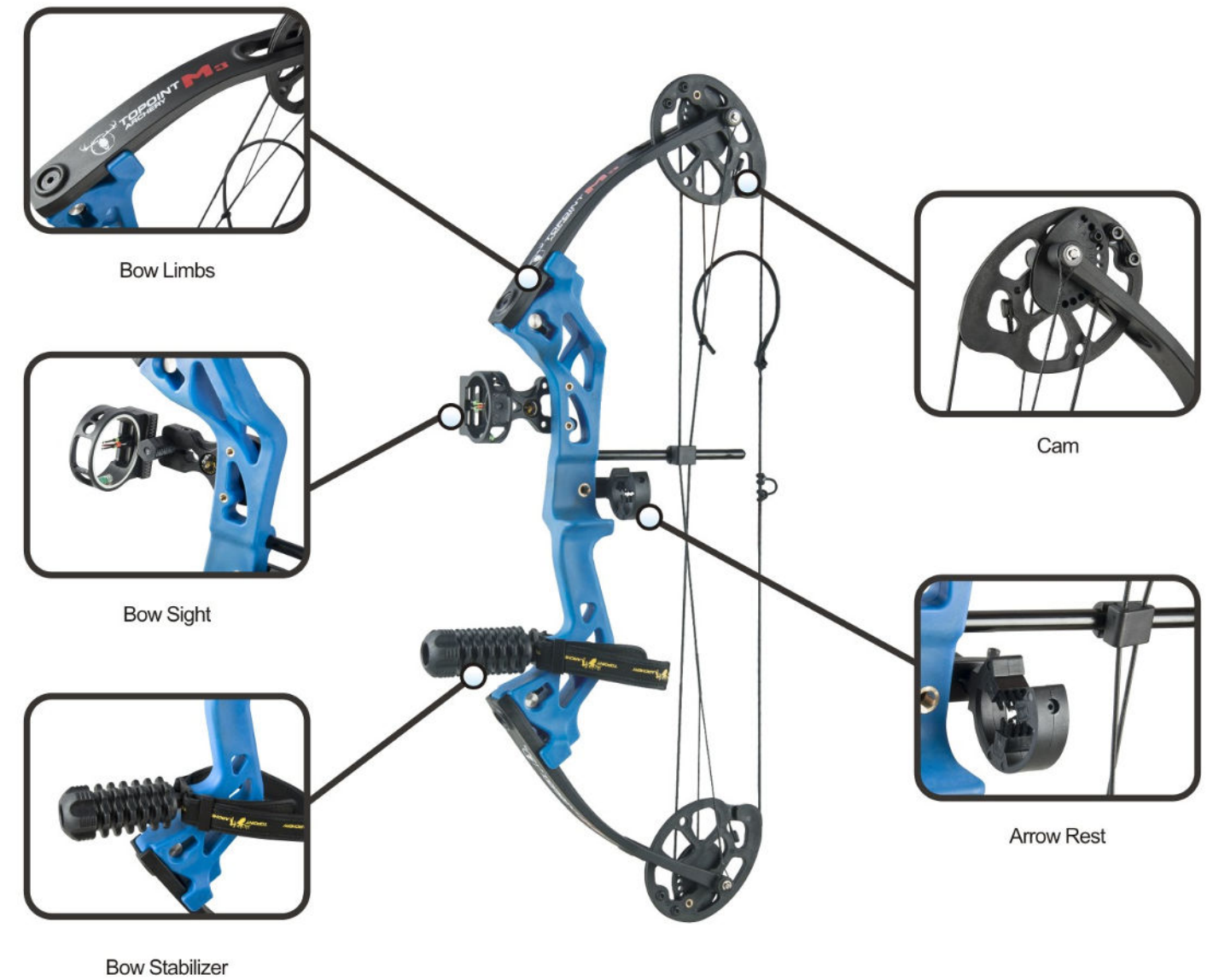

Bow Limbs

Bow Sight

Bow Stabilizer

Cam

Arrow Rest

COLOR OPTION

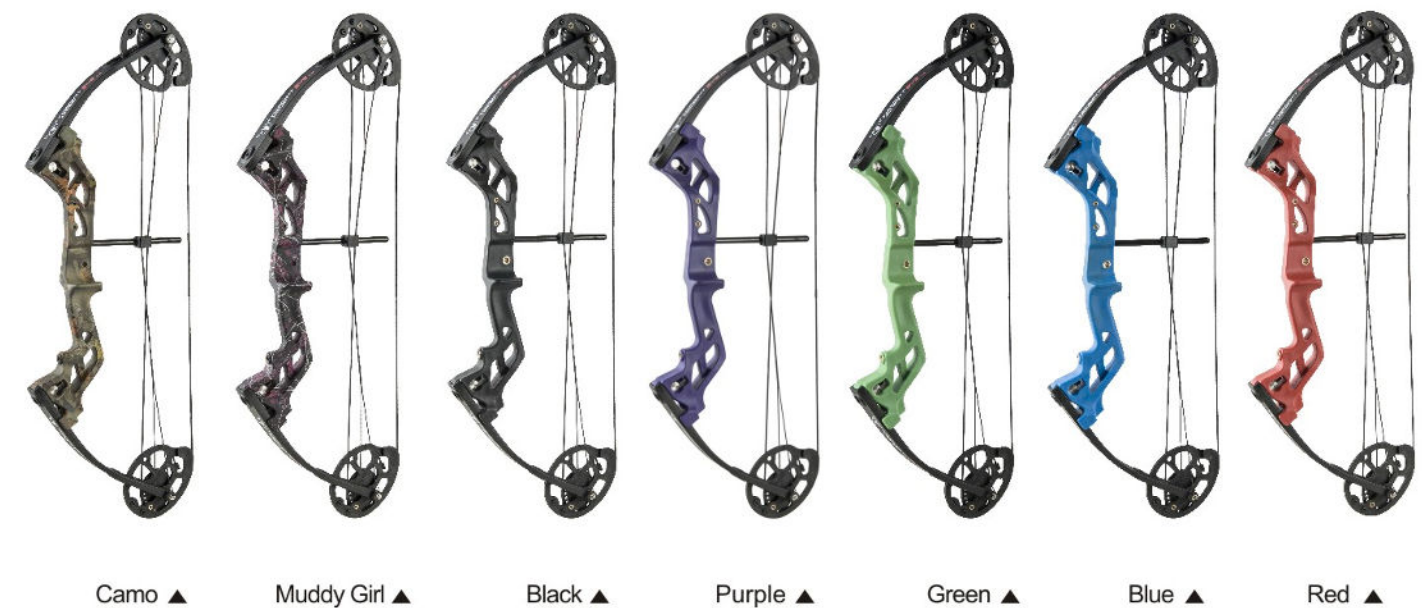

Camo ▲

Muddy Girl ▲





Black ▲



Purple ▲





Green ▲





Blue ▲





Red ▲

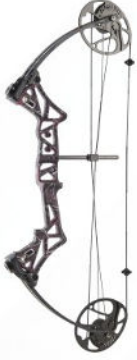

Model	Topoint Reliance 36		Topoint Reliance 38	
				
CAM	Dual/Adjustable(CAM1)	Dual/Adjustable(CAM2)	Dual/Adjustable(CAM1)	Dual/Adjustable(CAM2)
IBO Rate	Up to 330 fps	Up to 330 fps	Up to 330 fps	Up to 330 fps
Physical Weight	4.57 lbs	4.31 lbs	4.76 lbs	4.67 lbs
Axle to Axle	36"	36"	38"	38"
Brace Height	7"	6.75"	7.5"	7.3"
Let-off	75%	75%	75%	75%
Draw Weight	40,50,60lbs	40,50,60lbs	50,60lbs	50,60lbs
Riser	Aluminum CNC Machining	Aluminum CNC Machining	Aluminum CNC Machining	Aluminum CNC Machining
Finish	Anodized	Anodized	Anodized	Anodized
Draw Length	26.5-29.5",without Bow press	24-27",without Bow press	26.5-30.5", without Bow press	24.5-27.5", without Bow press
Bowstrings	BCY	BCY	BCY	BCY
String Length	59.7"	55.1"	61.8"	57"
Cable Length	35" X 2	35" X 2	36.8" X 2	36.8" X 2
Grip	Aluminum	Aluminum	Aluminum	Aluminum

Model	Topoint X	
		
CAM	Dual/Adjustable(CAM1)	Dual/Adjustable(CAM2)
IBO Rate	Up to 330 fps	Up to 330 fps
Physical Weight	4.85 lbs	4.76 lbs
Axle to Axle	40"	40"
Brace Height	7"	6.75"
Let-off	75%	75%
Draw Weight	50,60lbs	50,60lbs
Riser	Aluminum CNC Machining	Aluminum CNC Machining
Finish	Anodized	Anodized
Draw Length	27-31",without Bow press	25-28",without Bow press
Bowstrings	BCY	BCY
String Length	63.58"	58.66"
Cable Length	38.74" X 2	38.5" X 2
Grip	Aluminum	Aluminum

Model	Daibow Stronghold		Topoint Breth 36	
				
CAM	Dual/Adjustable(CAM1)	Dual/Adjustable(CAM2)	Dual/Adjustable(CAM1)	Dual/Adjustable(CAM2)
IBO Rate	Up to 330 fps	Up to 330 fps	Up to 330 fps	Up to 330 fps
Physical Weight	4.76 lbs.	4.67 lbs.	4.27 lbs.	4.18 lbs.
Axle to Axle	38"	38"	36"	36"
Brace Height	7.5"	7.3"	7"	6.75"
Let-off	75%	75%	75%	75%
Draw Weight	50,60lbs	50,60lbs	40,50,60lbs	40,50,60lbs
Riser	Aluminum CNC Machining	Aluminum CNC Machining	Aluminum CNC Machining	Aluminum CNC Machining
Finish	Anodized	Anodized	Anodized	Anodized
Draw Length	26.5-30.5", without Bow press	24-27", without Bow press	26-30", without Bow press	24-27", without Bow press
Bowstrings	BCY	BCY	BCY	BCY
String Length	61.8"	57"	59.5"	54.9"
Cable Length	36.8" X 2	36.8" X 2	35" X 2	35" X 2
Grip	Aluminum	Aluminum	Aluminum	Aluminum

Model	Daibow Acuity	Daibow Vigor	Daibow Tachyon	Daibow Momentous
				
IBO Rate	Up to 350 fps	Up to 350 fps	Up to 350 fps	320 fps
Physical Weight	4.22 lbs	4.63 lbs	4.3 lbs	3.9 lbs
Axle to Axle	28"	29.5"	31"	31.5"
Brace Height	6"	6"	6"	7"
Let-off	75%	75%	75%	80%
Draw Weight	50,60,70 lbs, adjustable	50,60,70 lbs, adjustable	50,60,70 lbs, adjustable	19-70lbs
Riser	Aluminum CNC Machining	Aluminum CNC Machining	Aluminum CNC Machining	Aluminum 6061-T6 CNC Milling
Finish	Anodized /Camo	Anodized /Camo	Anodized /Camo	Anodized, Camo
Draw Length	26-30", without Bow press	26.5-30.5",without Bow press	26.5-30.5", without Bow press	19-30", without bow press
Cam	Dual /Adjustable	Dual /Adjustable	Dual /Adjustable	Dual /Adjustable,7075-T6 CNC Milling
Bowstrings	BCY	BCY	BCY	BCY-X
String Length	56.3"	57.8"	58.86"	58.75"
Cable Length	27.63" X 2	28.7" X 2	29.13" X 2	33.938" X 2
Grip	Aluminum	Aluminum	Aluminum	Aluminum

	M1	M2	M3	T1
Model				
IBO Rate	320 fps	290 fps	260 fps	320 fps
Physical Weight	3.31 lbs	2.54 lbs	2.54 lbs	3.8 lbs
Axle to Axle	28"	25"	26"	31"
Brace Height	7"	6.8"	6.5"	7"
Let-off	80%	75%	75%	75%
Draw Weight	19-70lbs	10 - 40lbs,adjustable	10 - 30lbs,adjustable	19-70lbs
Riser	Aluminum	Aluminum	PA+ 30%GF	Aluminum 6061-T6 CNC Milling
Finish	Camo, Anodized	Powder-coated, Camo	Material base color/ Camo	Anodized, Camo
Draw Length	19-30", without bow press	17-27",without bow press	17-27", without bow press	19-30"(every 0.5" adjustable)without bow press
Cam	Dual /Adjustable,7075-T6 CNC Milling	Dual/Adjustable	Dual/Adjustable	Dual/Adjustable, With 2 Bearings
Bowstrings	BCY-X			BCY
Bow Limbs	Gordon Composites	Gordon Composites	PA+ 30%GF	Gordon Composites
String Length	55.55"	49.13"	48.6"	58.75"
Cable Length	30.78" X 2	27.95" X 2	28.74" X 2	33.938" X 2
Grip	Aluminum	Aluminum		Aluminum

	Trigon	TS330
Model		
IBO Rate	320 fps	330 fps
Physical Weight	3.75 lbs	3.75 lbs
Axle to Axle	31"	31"
Brace Height	7"	7"
Let-off	75%	75%
Draw Weight	19-70lbs	30-70lbs
Riser	Aluminum 6061-T6 CNC Milling	Aluminum CNC Machining
Finish	Anodized, Camo	Anodized /Camo
Draw Length	19-30", (every 0.5" adjustable)without bow press	25-31", without bow press
Cam	Dual/Adjustable,With 2 Bearings	Dual /Adjustable,7075-T6 CNC Milling
Bowstrings	BCY-X	BCY
String Length	58.75"	58.66"
Cable Length	33.938" X 2	32.48" X 2
Grip	Aluminum	Aluminum

	Begginer Package	Basic Package	Completely Package	Luxury Package
Accessories List				
Bow Sight	1X TP1550 5 Pin Bow Sight	1X TP1550 5 Pin Bow Sight	1X TP1550 5 Pin Bow Sight	1X TP1550 5 Pin Bow Sight
Arrow Rest	1X TP812 Brush Arrow Rest	1X TP813 Biscuti Arrow Rest	1X TP813 Biscuti Arrow Rest	1X TP813 Biscuti Arrow Rest
Bow Stabilizer	1X TP612 Rubber Stabilizer	1X TP617-5 Aluminum Stabilizer	1X TP617-5 Aluminum Stabilizer	1X TP617-5 Aluminum Stabilizer
Braided Bow Sling	1X TP313 Aluminum Mounting	1X TP313 Aluminum Mounting	1X TP313 Aluminum Mounting	1X TP313 Aluminum Mounting
Peep Sight	3X TP512-3/16	3X TP512-3/16	3X TP512-3/16	3X TP512-3/16
D-loop	Assembly 1pcs+ 1 Meter	Assembly 1pcs+ 1 Meter	Assembly 1pcs+ 1 Meter	Assembly 1pcs+ 1 Meter
Bow Release	1X TP410	1X TP412	1X TP412	1X TP412
Arrow Quiver			1X TP715 5pc Arrow Quiver	1X TP715 5pc Arrow Quiver
Arrow Bag	1X TP740 Arrow bag	1X TP740 Arrow bag	1X TP740 Arrow bag	1X TP740 Arrow bag
Arrow	12X 30" Fiberglass Arrow	12X 30" Carbon Mix Arrow	12X 30" Carbon Mix Arrow	12X 30" Carbon Mix Arrow
Limb Damper		1X TP109	1X TP109	1X TP109
Allen Key	1X TP111 9 Size combo	1X TP111 9 Size combo	1X TP111 9 Size combo	1X TP111 9 Size combo
Bowstring Wax	1X TP108	1X TP108	1X TP108	1X TP108
Bow Stand		1X TP110	1X TP110	1X TP110
Target Paper		5X TP113	5X TP113	5X TP113
Manual	1X	1X	1X	1X
Bow Case			1X TP86 Soft Bow Case	1X TP87 Hard Bow Case

Archery upgrade combo

TP800



- Bow sight: TP1430, 3pin bow sight, 0.029" fiber
- Arrow rest: TP812 brush arrow rest, left and right available
- Stabilizer: TP612 rubber stabilizer, 3.5 inches, 4.6 ounces
- Braided bow sling: TP317, Streamlined-design release head
- 6pcs allen key for assembly in compound bow
- Peep sight: TP512, silicone rubber peep sight, 1/8" hole size, 10ft D-loop

TP2000



- Bow sight: TP4550, 5pin, 0.019" fiber, tool-less, with sight light
- Arrow rest: TP813, whisker arrow rest, left and right available
- Stabilizer: TP617, CNC aluminum machined, 5", 5.3 oz
- Bow slings: TP311, durable leather easy to lock in any compound bow
- Allen key: 6pcs allen key for assembly in compound bow, 10ft D-loop
- Peep sight: TP512, 1/8", plastic peep sight with silicone rubber tubing

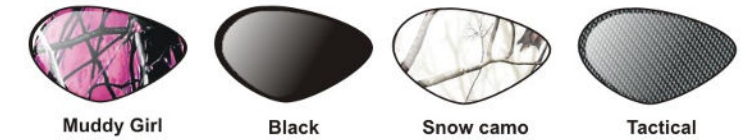

TP1000



- Bow sight: TP1550, 5pin bow sight, 0.029" fiber, with sight light
- Arrow rest: TP812 brush arrow rest, left and right available
- Stabilizer: TP612, rubber stabilizer, 3.5 inches, 4.6 ounces
- Braided bow sling: TP312, braided bow sling, camo, aluminum base
- 6pcs allen key for assembly in compound bow
- Peep sight: TP512, silicone rubber peep sight, 1/8" hole size, 10ft D-loop



Bow Sights Series



Black ▲

TP1330

- Long tumble to remove any machined mark
- Pins material: Brass
- Fiber optic diameter: 0.029" Color: Red, Green
- Shake-test passed
- Level with two vertical bars
- Adjustable for left and right handed shooters
- Markings for elevation and windage without LED light

TP1430

- Long tumble to remove any machined mark
- Pins material: Brass
- Fiber optic diameter: 0.029" Color: Red, Green
- Shake-test passed
- Level with two vertical bars
- Adjustable for left and right handed shooters
- Markings for elevation and windage without LED light



Black ▲



Black ▲

TP1530 Series

- Material: 6061-T6 aluminum
- CNC machined
- Long tumble to remove any machined mark
- Pins material: Brass
- Fiber optic diameter: 0.029" Color: Red, Green
- Shake-test passed
- Level with two vertical bars
- Adjustable for left and right handed shooters
- Markings for elevation and windage without LED light



Muddy Girl

Camo

Snow camo

Tactical

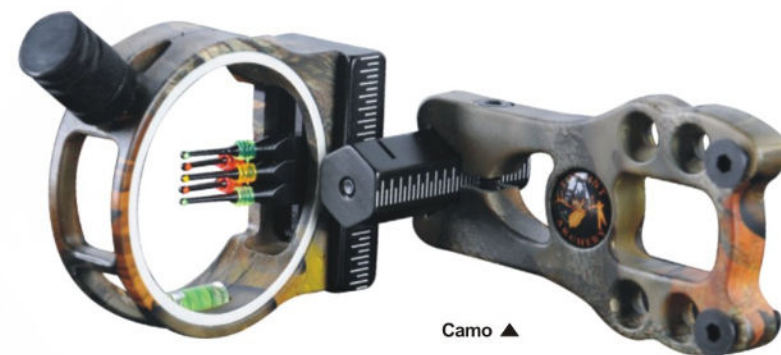

Camo ▲



Muddy Girl



Black



Snow camo



Tactical

TP1550 Series

- Material: 6061-T6 aluminum
- CNC machined
- Long tumble to remove any machined mark
- Pins material: Brass
- Fiber optic diameter: 0.029" color: Red, Green
- Shake-test passed
- Level with two vertical bars
- Adjustable for left and right handed shooters
- Markings for elevation and windage without LED light

TP3540 Series

- All parts use CNC machining, 6061-T6 material, matt black anodize
- Extra-long, fully protected wrapped fibers
- Micro, stainless steel tubes protect fibers
- Unique dual-end fiber design allows for increased pin brightness and compact size
- Aperture has 2.0" inner diameter
- Adjustment for windage and elevation
- Laser markings for windage, elevation
- Adjustable for left and right handed users
- With sight light
- Glow in the dark shooter's ring
- Fiber: 0.019", 4pins



Tactical ▲



Muddy Girl



Camo



Snow camo



Black



Muddy Girl ▲

TP4550 Series

- All parts use CNC machining, 6061-T6 material, matt black anodize
- Unique stainless steel tube pin design for increased durability and brightness
- Large circular field of view
- Aperture has 2" inner diameter
- Ultra-strong /lightweight construction
- With sight light
- Tool-less design



Camo

Black



Snow camo



Tactical

- Adjustable 2nd and 3rd axis level with two vertical bars
- Level is illuminated by luminescent tape
- Reversible bracket for greater vertical adjustability
- Markings for windage /elevation/pin adjustments
- Glow in the dark shooter's ring
- Adjustable for left and right handed shooters
- 5 pin, 0.019" fiber, green /yellow /red /yellow /green

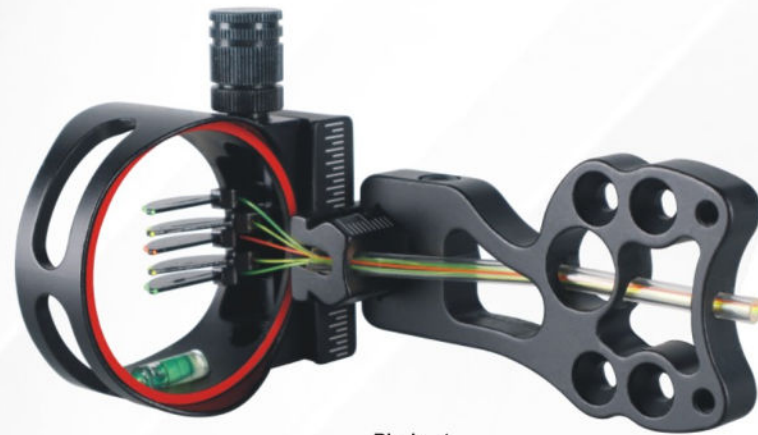

Black ▲

TP3650 Series

- All CNC machining aluminum parts
- Anodized satin black finish
- Five .019" full capture pins
- 2" diameter housing for an enlarged field of view
- Bubble level for precision shooting
- True Blue sight light included
- Fixed plate mount extends 3 3/4" to 4 1/4"
- Right or left land

TP6650 Series

- All CNC machining aluminum parts
- Anodized satin black finish
- Micro adjust windage & elevation
- Five .019" full capture pins
- 2" diameter housing for an enlarged field of view
- Bubble level for precision shooting
- True blue adjustable sight light included
- Fixed plate mount extends 4 1/4" to 4 3/4"
- Right or left hand



Black ▲

TP6550 Series

- Large circular field of view
- All parts use CNC machining, 6061-T6 material, matt black anodize
- Glow-in-the-dark shooter's ring
- Level is illuminated by luminescent tape
- Reversible bracket for greater vertical adjustability
- Markings for windage /elevation /pin adjustments
- Aperture has 2" inner diameter
- Ultra-fine click adjustment for windage and elevation
- Ultra-strong/ lightweight construction
- Adjustable for left and right handed shooters
- Adjustable 2nd and 3rd axis level with two vertical bars
- Unique stainless steel tube pin design for increased durability and brightness



Snow camo ▲



Muddy Girl

Camo

Tactical

Black

TP7550 Series

- 5 Pin design uses stainless steel tubing for even greater durability
- Detachable bracket/ Tool-less design
- Ultra-fine click adjustment for windage and elevation
- Large circular field of view
- One-piece head reduces vibration
- Adjustable level with two vertical bars
- Level is illuminated by luminescent shooter's ring
- Reversible bracket for greater vertical adjustability
- Three sets of markings for elevation, windage and pin adjustments
- Lighted models are designed to reduce unwanted pin glare
- Pin, 0.019" fiber, green /yellow /red /yellow /green
- 2 position for sight light, adjustable sight light

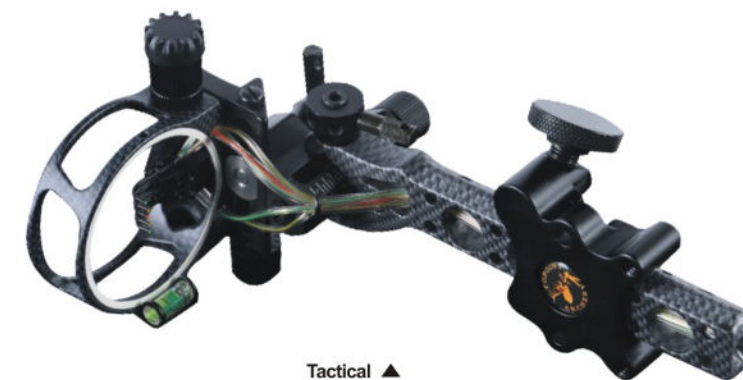

Tactical ▲



Muddy Girl

Camo

Snow camo

Black

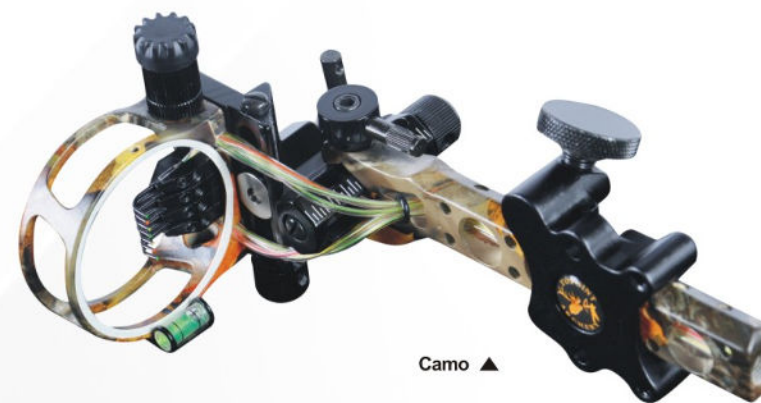

Camo ▲



Muddy Girl

Black

Snow camo

Tactical

TP7570 Series

- 7 Pin design uses stainless steel tubing for even greater durability
- Detachable bracket /Tool-less design
- Ultra-fine click adjustment for windage and elevation
- Large circular field of view
- One-piece head reduces vibration
- Adjustable level with two vertical bars
- Level is illuminated by luminescent shooter's ring
- Reversible bracket for greater vertical adjustability
- Three sets of markings for elevation, windage and pin adjustments
- Lighted models are designed to reduce unwanted pin glare
- Pin, 0.019" fiber, green /yellow /red /yellow /green
- 2 position for sight light, adjustable sight light



Tactical ▲

TP9510 Series

- Brightest 1-pins archery sight
- Extra long, fully protected wrapped fiber
- CNC machined, precision linkage system
- Tool-less lock
- Aperture has a 2" inner diameter

- Micro-adjust windage precision click design
- Ultra-smooth bracket for easy one-hand adjustment
- Glow in the dark shooter's ring helps align peep sight
- Clean, circular sight picture with all-metal, 0.19" pin



Black ▼

TP8510

- Precision machined aluminum components for both right and left hand shooters
- Super light and strong with absolute shot accuracy and designed for use on both recurve and compound bows
- Worm gear sight bar with etches markings
- Single sight pin with square sight pin aperture
- Detachable bracket
- Ultra-fine click adjustment for windage and elevation

DB8150 Series

- Large circular field of view
- Aperture has 2" inner diameter
- Ultra-strong /lightweight construction
- Glow-in-the-dark shooter's ring
- Adjustable 2nd and 3rd axis level with two vertical bars.
- Level is illuminated by luminescent tape
- Reversible bracket for greater vertical adjustability
- Markings for windage /elevation/pin adjustments
- Adjustable sight light, 2 position for sight light
- Adjustable for left and right handed shooters
- Ultra-fine click adjustment for windage and elevation
- Unique stainless steel tube pin design for increased durability and brightness
- All part use CNC machining, 6061-T6 material, anodize /camo
- 5 Pins or 7 Pins available



Camo

Black

DB8250 Series

- Detachable bracket
- Large circular field of view
- Aperture has 2" inner diameter
- Ultra-strong /lightweight construction
- Glow in the dark shooter's ring
- Adjustable 2nd and 3rd axis level with two vertical bars
- Level is illuminated by luminescent tape
- Reversible bracket for greater vertical adjustability
- Markings for windage/elevation/pin adjustments
- Adjustable sight light, 2 position for sight light
- Adjustable for left and right handed shooters
- Ultra-fine click adjustment for windage and elevation
- Unique stainless steel tube pin design for increased durability and brightness
- All part use CNC machining, 6061-T6 material, anodize /camo
- 5 Pins or 7 Pins available



Camo

Black

MICRO ADJUSTABLE BOW SIGHT

Provides instant feedback that will identify even the slightest torque or anchor point change.



DB9150 Series

- Micro adjust windage and Elevation Knobs
- Bubble level with 2nd axis adjustment for a more accurate shot
- Tool-free locking knobs included
- Adjustable 2nd Axis
- 5 Pins or 7 Pins available



Camo

Black



DB9250 Series

- 6Inch extension bar
- Quiver compatible mounting block
- Bubble level with 2nd axis adjustment for a more accurate shot
- Adjustable 2nd axis
- 0.019 fiber optic pins
- Tool-free locking knobs included
- Precise incremental adjustment windage and elevation
- knobs 0.0015 per click
- 5 Pins or 7 Pins available



Target Compound Bow Sight



TP8810 Series

- Compound Bow sight
- Carbon bracket
- Lightweight
- Quick release fast vertical adjustment
- 9" extension
- Windage and elevation adjustment
- RH and LH available
- Incl. Soft case
- 3rd axis adjustable removable head
- Available color : Black, Blue, Turquoise, Red, Smoke, Purple, Green, Orange

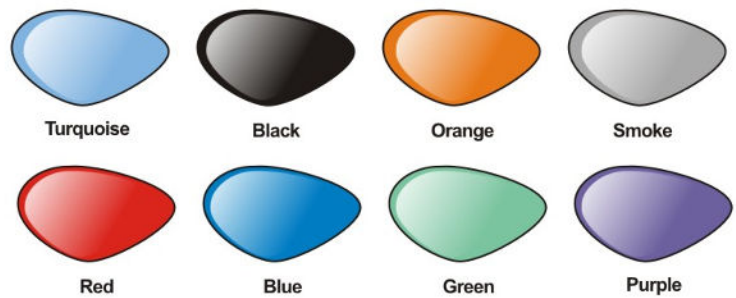

TP8710-Bow Sight Scope With Lens



- 7075 Aluminum CNC machining
- 29mm diameter
- Anodized Finish
- 0.019 fiber
- 2X, 4X, 6X, 8X Lens Selection
- Available color : Black, Blue, Turquoise, Red, Smoke, Purple, Green, Orange



TP8720-Scope Lens

- CNC Machining
- 2x /4x /6x /8x
- Outer: 35mm
- Lens: 30mm

TP8710-PRO Bow Sight Scope With Lens

- Level of competition
- 7075 Aluminum CNC machining
- 29mm diameter
- Anodized Finish
- 0.019 fiber
- 2X, 4X, 6X, 8X Lens Selection
- Available color : Black, Blue, Turquoise, Red, Smoke, Purple, Green, Orange



TP8720-PRO Scope Lens

- Level of competition
- CNC Machining
- 2x /4x /6x /8x
- Outer: 35mm
- Lens: 30mm



TP8750-Bow Sight Scope With Lens

- Aircraft-grade 7075 aluminum with precision machining of CNC
- Level of competition
- 28mm diameter
- High-performance glass with antireflection coating that keeps your vision clear, helps you get rid of the double image
- Lens can be easily exchanged without changing your aim point
- Screw rod: Metric thread 10-32
- There is O-ring inside the bow sight to prevent the loose

- The unique groove design prevents light fiber from being exposed but make the fiber efficiently absorb light
- Fiber diameter :0.019"
- 2x /4x /6x /8x
- Outer: 35mm
- Lens: 30mm
- Long range front lens hood with integrated design
- Fluorescent ring can keep your attention focusing and can be exchanged with a full circle rear lens hood

Arrow Rests



Black ▲

TP811 Series

- Total arrow containment
- Little or no fletch damage
- Vertical and horizontal adjustment
- Reduce friction
- Works for both right hand and left hand



TP812 Series

- Total arrow containment
- Little or no fletch damage
- Vertical and horizontal adjustment
- Reduce friction
- Works for both right hand and left hand

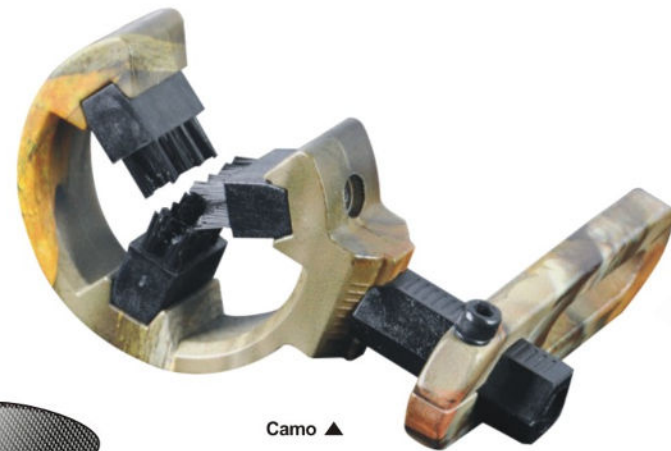

Camo ▲

TP813 Series

- Total arrow containment
- Little or no fletch damage
- Vertical and horizontal adjustment
- Reduce friction
- Works for both right hand and left hand



Black ▲



Camo-Right hand ▲

Black-Left hand ▲

TP814 Series

- New sleek curved capture bar for more versatility
- New designed vertical for more versatility
- Advanced Vibration Technology
- Lock Down Technology Guarantees No Bounce Back
- Total Arrow containment
- Easily adjust the timing cord with clamp or cord lock
- Noise reducing, soft rubber cover
- Break away safety feature
- Vertical, Horizontal and overdraw adjustments
- Precision CNC aluminum, stainless steel and components

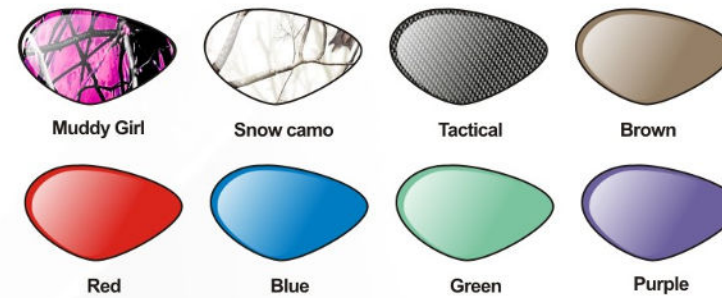

TP815 Series

- Tool-less design
- Middle size
- Left Hand and right hand selected
- Ultra-fine click adjustment for windage and elevation
- CNC aluminum brush holder and other parts, very strong, durable
- Hold your arrow safely and securely



Left ▲

Right ▲

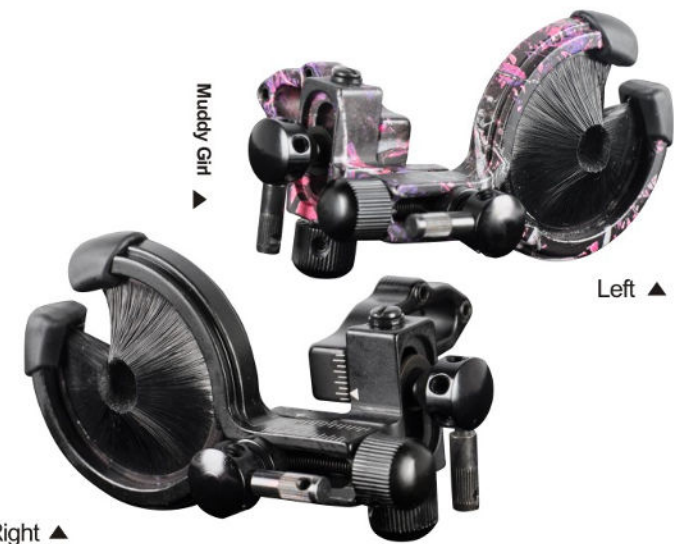

Muddy Girl ▲

Left ▲

Right ▲

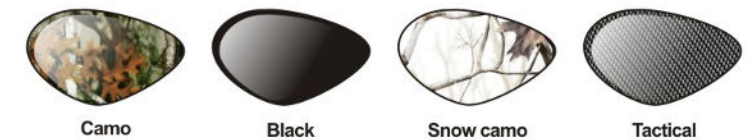

Camo

Black

Snow camo

Tactical

TP816 Series

- It can be used on Compound bow, Recurve bow
- Holds your arrow safely and securely
- Lighter, more compact
- Biscuit is stronger
- Reference marks for windage adjustment
- Fits RH/LH handed Bows



Camo ▲



Muddy Girl

Camo

Snow camo

Black

TP824 Series

- Aluminum CNC milling, lightweight and compact
- High-performance drop-away design
- Quick and easy installation - no Bow press required
- Bearing increase downward speed at launch, adjustable down speed
- Technical rubber dampeners silence arrow loading
- For left and right-handed bows

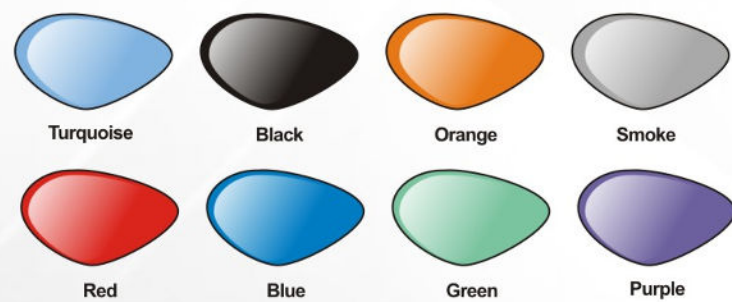

Turquoise

Black

Orange

Smoke

Red

Blue

Green

Purple

TP826 Series

- Fully micro adjustable
- Adjustable blade angle
- Laser-etched adjustment lines and oversized lock-down screws
- Length adjustable by using accessories come with package
- Comes with Four standard width launcher blades in 0.3mm thickness and wide width in 7.7mm, 0.25mm thickness and wide width in 4mm, 0.25mm thickness and wide width in 5mm, 0.3mm thickness and wide width in 5mm
- Available color : Black, Blue, Turquoise, Red, Smoke, Purple, Green, Orange
- With extend bracket, for any brand target compound bow

TP830 Series

- Holds your arrow safely and securely
- Lighter, more compact
- Reference marks for windage adjustment
- Left and right all are available



Black ▲



Muddy Girl

Camo

Snow camo

Black



Black ▲

TP831 Series

- Tool-less design
- Middle size
- Left Hand and right hand selected
- Ultra-fine click adjustment for windage and elevation
- CNC aluminum brush holder and other parts, very strong, durable
- Hold your arrow safely and securely



Muddy Girl

Camo

Snow camo

Black

Target compound bow stabilizer



PR602 Stabilizer Combo

- PR602-MAIN-31.5" *1, (286g)
- PR602-SIDE-10" *2 ,(105g)
- PR605-EXTEND-4" *1, (43g)
- PR609(40 degree V-BAR mount) *1
- PR611(Connect bolt) *1
- Material: 3K Pure carbon, Aluminum alloy



PR601-MAIN

- Material: 3K Pure carbon, Aluminum alloy
- Size: 18" 24" 27" 30" 34"
- Weight: 109g /123g /130g /138g /147g

PR601-SIDE

- Material: 3K pure carbon, Aluminum alloy
- Size: 8" 10" 12"
- Weight: 85g /90g /95g



PR602-MAIN

- Material: 3K Pure carbon, Aluminum alloy
- Size: 18.5" 28.5" 31.5" 34.5"
- Weight: 255g /278g /286g /293g



PR601 Stabilizer Combo

- PR601-MAIN-30" *1, (138g)
- PR601-SIDE-10" *2 ,(90g)
- PR605-EXTEND-4" *1, (43g)
- PR609(40 degree V-BAR mount)*1
- PR611(Connect bolt) *1
- Material: 3K Pure carbon, Aluminum alloy

PR602-SIDE

- Material: 3K pure carbon, Aluminum alloy
- Size: 10" 12" 15"
- Weight: 105g /110g /117g



PR603 Stabilizer extend

- Material: Aluminum alloy
- Size: 45"
- Weight: 140g

PR604-MAIN

- Material: 3K pure carbon, Stainless steel
- Size: 24" 27" 30" 33"
- Weight: 315g /320g /327g



PR604-SIDE

- Material: 3Kpure carbon, Stainless steel
- Size: 10" 12" 15"
- Weight: 315g /320g /327g

PR605-EXTEND

- Material: 3K pure carbon, Aluminum Alloy
- Size: 4" 5" 6"
- Weight: 43g /45g /48g



TOP-X

Longrod bowstabilizer

Top X carbon weave used in construction
 Increased balance and vibration absorption control
 Designed to minimize movement
 from even the highest speed bows
 Ideal for recurve bows
 Lightweight diameter 15mm carbon rods

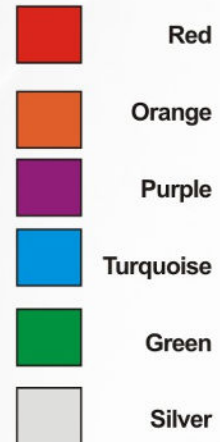

PR633 Stabilizer Combo

- PR633-MAIN-30" *1, (358g)
- PR633-SIDE-10" *2 ,(311g)
- PR633-EXTEND-5" *1, (68g)
- PR608 (40 degree V-BAR mount) *1
- PR610 (Connect bolt) *1
- Material: Pure Carbon, Rubber, Alloy



PR633-MAIN

- Material: Pure Carbon, Rubber, Alloy
- Size: 24" 27" 30" 33"
- Weight: 345g /350g / 358g /365g



PR633-SIDE

- Material: Pure Carbon, Rubber, Alloy
- Size: 10" 12" 15"
- Weight: 311g /316g / 322g



PR633-EXTEND

- Material: Pure Carbon, Alloy
- Size: 4" 5" 6"
- Weight: 66g /68g / 70g

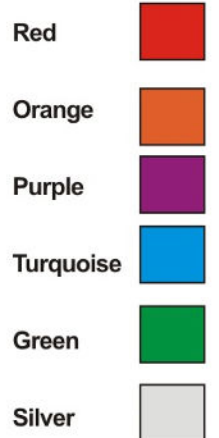

PR634 Stabilizer Combo

- PR634-MAIN-30" *1, (193g)
- PR634-SIDE-10" *2 ,(145g)
- PR633-EXTEND-5" *1, (68g)
- PR608(40 degree V-BAR mount) *1
- PR610(Connect bolt) *1
- Material: Pure Carbon, Alloy



PR634-MAIN

- Material: Pure Carbon, Alloy
- Size: 18" 24" 27" 30" 34"
- Weight: 165g /177g /185g /193g / 202g



PR634-SIDE

- Material: Pure Carbon, Alloy
- Size: 10" 12" 15"
- Weight: 145g /151g / 158g

TOP-X PRO

HIGH-MOD

LEVEL OF COMPETITION LONG ROD BOV STABILIZER



PR651-MAIN

- Length: 30", 33"
- Weight: 6.21 oz. (176g), 6.49 oz. (184g)
- 12.7 (OD) X 8.0 (ID) mm
- 40T, 3K high mod carbon rod
- Level of competition



PR652-MAIN

- Length: 30", 33"
- Weight: 15.22 oz. (431.5g), 15.50 oz. (439.5g)
- 12.7 (OD) X 8.0 (ID) mm
- 40T, 3K high mod carbon rod
- Level of competition



PR653-MAIN

- Length: 30", 33"
- Weight: 15.22oz. (446g), 16.01oz. (454g)
- 12.7 (OD) X 8.0 (ID) mm
- 40T, 3K high mod carbon rod
- Level of competition

PR651-SIDE

- Length: 12", 15"
- Weight: 3.00 oz. (85g), 3.22 oz. (91.3g)
- 10.2 (OD) X 6.2 (ID) mm
- 40T, 3K high mod carbon rod
- Level of competition



PR652-SIDE

- Length: 12", 15"
- Weight: 11.99 oz. (340g), 12.23 oz. (346.7g)
- 10.2 (OD) X 6.2 (ID) mm
- 40T, 3K high mod carbon rod
- Level of competition



PR653-SIDE

- Length: 12", 15"
- Weight: 12.52 oz. (355g), 12.77oz. (362g)
- 10.2 (OD) X 6.2 (ID) mm
- 40T, 3K high mod carbon rod
- Level of competition

ACCESSORIES



PR606-Double Adjustable V-BAR mount



PR607-Single Adjustable V-BAR mount



PR608-40 degree V-BAR mount



PR609-40 degree V-BAR mount, down 10 degree



PR610-Stabilizer Bomb



PR611-Connect bolt



PR613-Conversion screw



PR614-Quick discount bolt



PR615-Single weight



PR616-Double weight



PR617-Four weight



PR632-Quick discount bolt



PR654-Bright stainless steel weight pieces with aluminum stabilizer combo



PR655-Bright stainless steel weight pieces with stabilizer bomb combo



PR656-Aluminum stabilizer



PR657-Single weight



PR658-Double weight



PR659-Four weight



PR660-Barebow Weight

- Weight: 16.33 oz. (463g)
- 49 *58mm



PR660-Spectra

- Weight: 16.33 oz. (463g)
- 49 *58mm



PR665-Double Adjustable V-BAR mount



PR666-Single Adjustable V-BAR mount



Bow Riser Stabilizer-PR680

Bow Stabilizers Series



TP612 Series

- Modular Weights for Customization of Weight Placement
- Optimized for Stiffness and Vibration Reduction
- Time-Tested Shock Rod Technology Available in 5 Custom Colors
- Weight: 6" (5 oz.)

Black ▲



Muddy Girl

Camo

Snow camo

Tactical

TP625 Series

- CNC machined from 6061-T6 aluminum
- Vibration dampening technology
- Aluminum Anodized, more color select
- Connected to 3" / 4.5" / 6" / 7.5" / 9" more
- Weight: 1.45ounces
- Length: 1.5inches



TP621 Series

- Modular Weights for Customization of Weight Placement
- Optimized for Stiffness and Vibration Reduction
- Time-Tested Shock Rod Technology Available in 5 Custom Colors
- Weight: 6" (5 oz.)



Camo ▲



Muddy Girl

Black

Snow camo

Tactical

TP615 Series

- 80% less wind drag Reduce the affect of hand-torque during the shot cycle
- CNC machined Harmonic stabilizer technology
- Comes complete with harmonic dampers

Model	Length	Weight
TP615-2	2"	5.8 OZ
TP615-3	3"	6.5 OZ
TP615-4	4"	7.0 OZ
TP615-5	5"	7.5 OZ
TP615-6	6"	8.5 OZ
TP615-8	8"	8.5 OZ
TP615-11	11"	9.5 OZ

TP615-2 Series



Muddy Girl

Camo

Snow camo

Black

Red

Tactical ▲



TP615-3 Series ▲



TP615-5 Series ▲



TP615-8 Series ▲

TP617 Series

- CNC machined from 6061-T6 aluminum
- Vibration dampening technology
- Hatching knurling easy to lock in compound bow

Model	Length	Weight
TP617-5	5"	5.3 OZ
TP617-8	8"	6.5 OZ
TP615-11	11"	10 OZ



Muddy Girl

Camo



Black

Snow camo

Tactical



TP615-4 Series ▲



TP615-6 Series ▲



TP615-11 Series ▲



TP617-5 Series ▲



TP617-8 Series ▲



TP617-11 Series ▲

3K CARBON BOW STABILIZER



TP623 Series

- CNC MACHINED FROM 6061-T6 aluminum
- Vibration dampening technology
- Easy to lock in compound bow
- Length: 5"/8"
- Weight: 213g(5"),250g(8") with 2pcs 25g adjust weight
- Color: Black , Camo, Muddy girl

Model	Length	Weight
TP623-5	5"	213g
TP623-8	8"	250g

TP623-5 Series ▲

TP623-8 Series ▲



TP640 Series

- The ultimate in vibration dampening stabilizers
- Features exclusive dampening technology with new EHS Nano configuration for added vibration dampening and enhanced stabilization
- EHS Nano paired with a high modulus 3K Carbon fiber rod and precision CNC machined end cap weights to ensure ultimate rigidity, while allowing you to control the amount of added weight

Model	Length	Weight
TP640-6	6"	290g
TP640-8	8"	298g



TP640-6 Series ▲

TP640-8 Series ▲

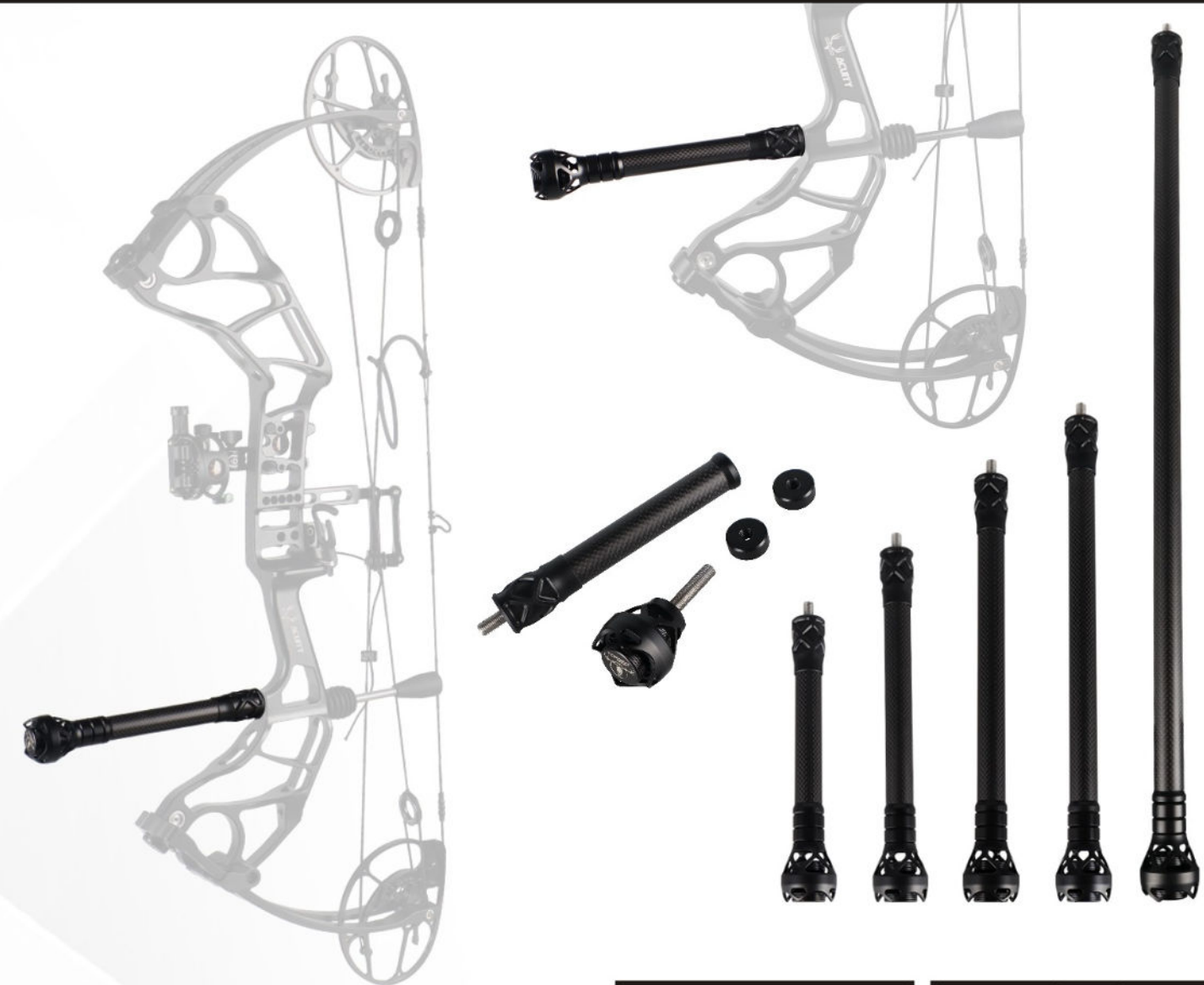
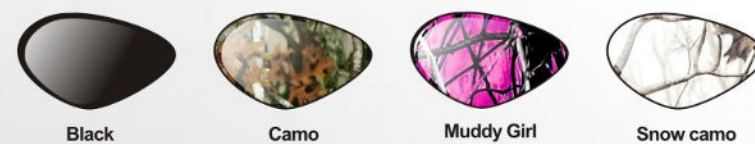

TP626 Series

- The ultimate in vibration dampening stabilizers
- High modulus 3K Carbon fiber rod and precision CNC machined end cap weights to ensure ultimate rigidity,
- While allowing you to control the amount of added weight

Model	Length	Weight
TP626-6	6"	238g
TP626-8	8"	242g
TP626-10	10"	246g
TP626-12	12"	250g
TP626-24	24"	271g





TP465 Thumb / Back Tension Release Hybrid

- Thumb Bow Release and back tension release available
- Aluminum and brass cnc body
- Release travel adjustable
- 3 and 4 fingers available
- Finger piece perfect fit adjustable
- Three size thumbs available: large, medium, and small



TP462 Back Tension Release

- Aluminum CNC body with brass insert for added weight
- Release travel adjustable
- 3 and 4 finger articulating handle pieces included
- Finger piece perfect fit adjustable





TP460 Back Tension Release

- Aluminum CNC body with brass insert for added weight
- Release travel adjustable
- 3 and 4 finger articulating handle pieces included
- Finger piece perfect fit adjustable



TP425

- 4 finger available
- Aluminum CNC machining body
- S.S. jaw, adjustable sensitive,
- Anodized 7 color select, red, black, smoke, green, blue, golden, purple



TP423

- Aluminum CNC machining body
- Anodized 5 color select: Red, Blue, Black, Orange, Green



TP420

- Thinner head and jaw to reduce D-loop torque
- Safe firing mechanism - so safe that even if a piece of paper is in the way, the release will not set
- Silent & easy cocking firing mechanism
- Aluminum CNC machining main body,
- Stainless steel Release structure
- 3 and 4 Fingers available



TP435

- CNC MACHINING
- 360 degree swivel caliper head, for both right and left
- Auto closure jaws
- Adjustable buckle wrist strap
- Fits youth and adult



TP410

- Lightweight aluminum head
- Precision tuned trigger
- Adjustable wrist strap



- Precision trigger
- Adjustable rope length
- Foldable head
- Anodized 8 color select, red, black, smoke, green, blue, orange, purple, turquoise



TP410-S

- Lightweight aluminum head
- Precision tuned trigger
- Adjustable wrist strap
- Length: 9.7cm
- For Youth , children archer



TP412

- Swivel mounted caliper head
- Precision trigger
- Adjustable velcro strap
- Streamlined-design release head
- Posi-lock hook up for quick attachment to the string



TP414

- Factory turned trigger
- 360 degree swivel mounted caliper head
- Molded handle with rubberized gripping surface
- Hand hold



TP413

- Auto closure jaws
- Buckle wrist strap
- Fits youth and adult
- 360 degree swivel caliper head, for both right and left



TP415

- Easily Adjustable Slide-Lock Technology
- Super Smooth Trigger
- Fast, Clean Jaw Release
- Wont Torque Bow String
- Fits Adults & Youth
- Padded Leather Wrist Strap Buckle Adjust

Arrow Quivers

TP715 Series

- Double gripper design with removable upper gripper
- Compact, lightweight, carbon tube structure
- Rubber hood insert reduces noise and won't dull broadheads
- Holds up to five arrows
- Fits both carbon and aluminum arrows
- Quick lock mounting bracket
- Fully adjustable
- Fits both mechanical and fixed broadheads



Black ▲

TP726 Series

- Double gripper design with removable upper gripper
- Compact, lightweight
- Holds up to 6 arrows
- Fits both carbon and aluminum arrows
- Quick lock mounting bracket
- Fits both mechanical and fixed broadheads
- Rubber hood insert reduces noise and won't dull broadheads



Muddy Girl

Camo

Snow camo

Tactical

TP740



TP720

- Material: PP
- Length: 63cm-100cm, any size adjustable
- 12pcs arrow package, suit for any compound bow
- Arrow, cross bow arrow
- With straps



TP772

- 13.5 *24.5 *33.5cm
- Boxes can hold 72pcs arrow

TP760

- Weight: 475 gr
- Length: 42cm
- Direction: RH
- Color: Turquoise/ Smoke/ Orange/ Green
- 2 pockets
- Slot for pen
- Slot for t- gauge
- 2 D-loop rings
- 3 Sounddamping separators
- Belt included



TP765

- Release or Finger Tab Pouch
- Weight: 75 gr
- Color: Smoke/Orange/Green/Turquoise
- Durable Nylon Fabric
- Quick draw closure
- Inner divider separator
- Webbed loop to easily attach to a belt

TP785 Series

- Double gripper design
- Compact, lightweight, carbon tube structure
- Foam insert reduces noise and won't dull broadheads
- Holds up to five arrows
- Fits both carbon and aluminum arrows
- Quick lock mounting bracket
- Fully adjustable
- Fits both mechanical and fixed broadheads



Black



Camo



Muddy Girl



TP795 Series

- Single gripper design Compact, lightweight
- Holds up to 5 arrows
- Fits both carbon and aluminum arrows
- Quick lock mounting bracket
- Fits both mechanical and fixed broadheads
- Foam insert reduces noise and won't dull broadheads



Black



Camo



Muddy Girl



▶ **Bow Tuning** ◀



TP119-Bow Press

- Heavy-duty pro-shop-quality
- Simple, hands-free operation
- Install new bow, repair bow, assembly peep sight, adjust compound bow
- All Steel structure



TP112-String Level Combo

- Take the guesswork out of nock positioning
- Secure your bow in a vise, clip on the String Level and adjust the vise
- Until the bow is at horizontal and vertical level
- Place the nock arrow on the rest and attach the Level to the arrow
- Slide the arrow up or down on the string until it is level
- You've now located the perfect 90° nock positioning needed for precision tuning
- Combo includes arrow level and String Level



TP116-BOW VISE

- Heavy-duty pro-shop-quality
- Holds bow horizontally or vertically
- Allows bow to swivel 360°
- Simple, hands-free operation



TP117-Center Laser Aligner

- Toolless knobs facilitate super-easy mounting
- Durable aluminum construction promotes longevity
- Built-in level ensures accurate measurements
- 360° rotating head and pivoting body design
- Highly-visible red laser provides quick alignment references



TP118-D-LOOP Plier

- For compound bow D-loop and brass button plier

▶ **Braided Bow Slings** ◀

TP311

- Ultra-durable braided nylon cord material
- Durable leather front strap with stainless steel grommet
- Designed to stay in upright position to make grabbing your bow as easy as possible



Pink ▲



Camo▲

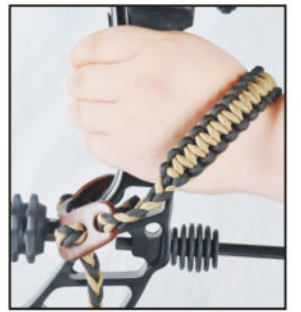

TP313

- Custom braided high quality
- Double-wide for comfort
- Extra long length for maximum adjustability
- CNC machined mounting adapter performs
- Easy to mount



Black ▲

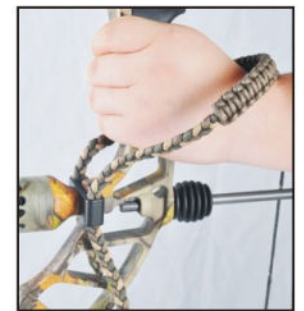

Camo▲

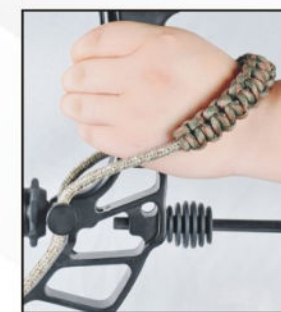

TP316 Camo▲



Blue ▲



Black ▲



TP315 Camo▲

TP317

- Swivel mounted caliper head
- Precision trigger
- Adjustable velcro strap
- Streamlined-design release head
- Posi-lock hook up for quick attachment to the string



Bow Cases



TP86

- Function: Exclusive for compound bows
- Material: Nylon
- Net weight: 1.95KG
- Size: 5.5 *18.1 *41.3 inches



TP95

- For 40" Target compound bow
- Material: 100% POLYESTER
- Net Weight: 1.5kg
- Size: 115 x 44cm



TP89

- Function: Exclusive for compound bows
- Material: Nylon
- Size: W:95cm

▲ Black



▲ Camo

TP90

- Function: For T1 & M1
- Material: Nylon
- Net weight: 1.04KG
- Size: 5.5 *17.3 *39.0inches



TP83

- Size: 110.8X43X17cm
- Material: PE
- It is lockable and has a lot of room to store arrows and accessories
- 6pcs arrow holder



TP84

- Size: 115 x 54 x 17cm
- Material: PE
- It is lockable and has a lot of room to store arrows and accessories
- 12pcs arrow holder

TP87

- Size: 109 *44.5 *16.5cm
- Material: PP
- It is lockable and has a lot of room to store arrows and accessories
- 12pcs arrow holder



TP85

- Size: 88.5 x 22.5 x 8cm
- Material: PE
- 16pcs arrow holder

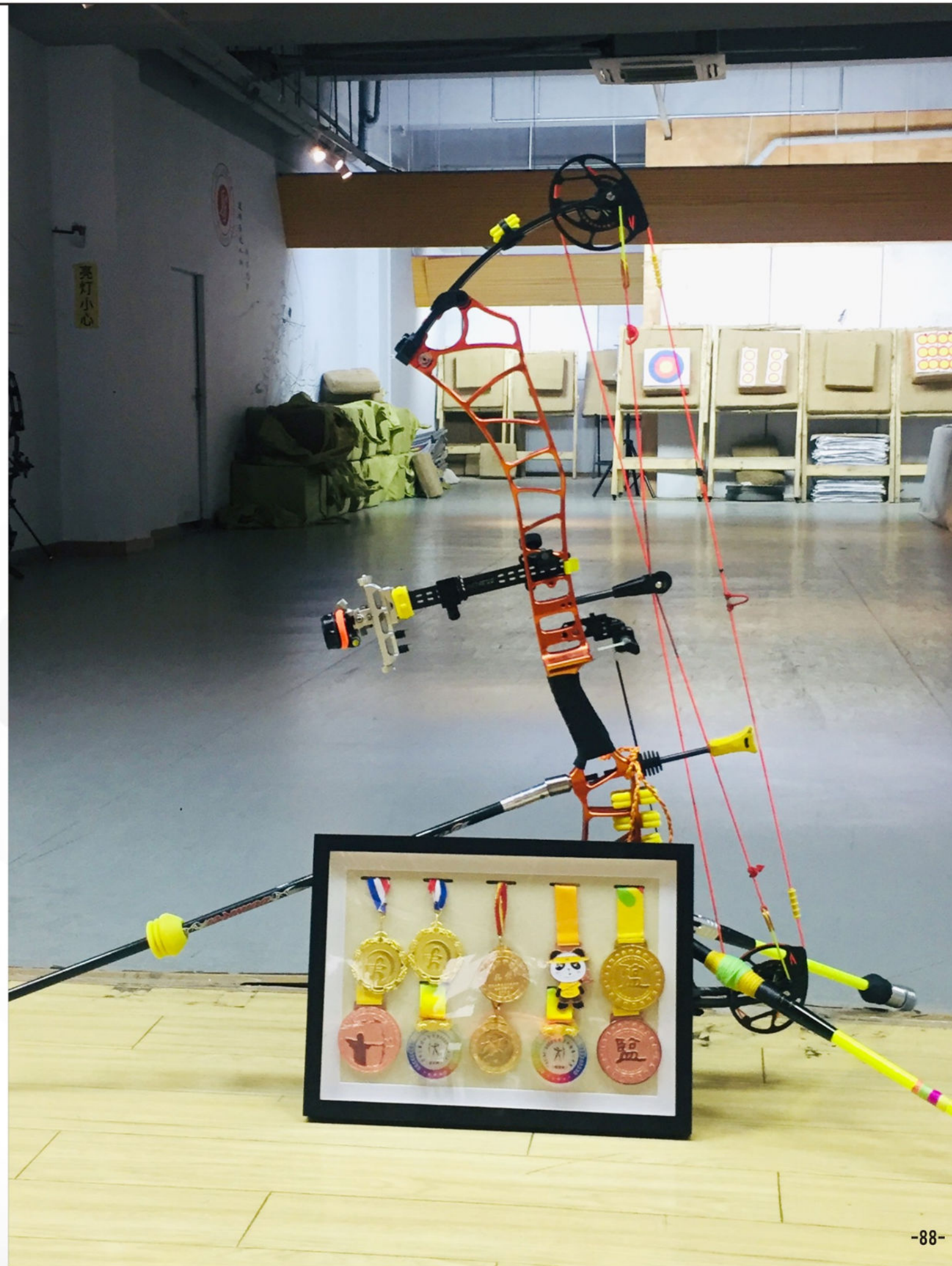

Peep Sights



TP511

- Aluminum cnc machined
- 1/4", 3/16", 1/8", 3 size style
- Anodize 3 color, black, green, red



TP512

- Easily aligns with pin guard
- Great for hunting or target shooting
- Self aligning and reliable
- Unique angled design that allows for clearer field-of-view
- Designed to fit all bows
- 1/8" or 3/16" size
- Includes high-grade tubing for perfect positioning

TP515

- 37 degree and 45 degree available
- Accepts all Archery apertures, clarifiers
- Anodize 4 color, black, green, red, black
- Hooded Super Ball Pro Series Peep is lighter than the original Hooded Super Peep housing for increased speed

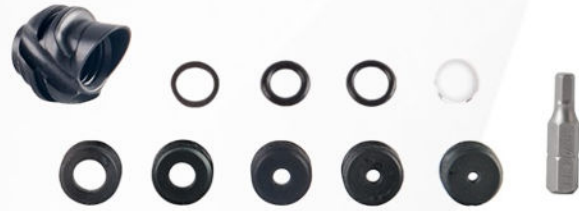

Clarifiers-TP516

- Aluminum CNC
- 37 degree and 45 degree available
- Available in Black, Blue and Red
- Apertures: 1/8" 3/32" 1/16" 1/32" 3/64" Peep Reducer



Archery Accessories



TP101-Adjustable bow sight light

- Lights up your sight ping
- 3/8-32 thread
- Fits APEX, COBRA, COPPER JOHN, PSE, TROPHY RIDGE AND TRUGLO sights and more



TP102-Relplacement pin

- Precision-machined brass pins
- Fits 3/16" slotted sights
- Wrapped fiber provides greater bright-ness
- Available in .029" diameter only
- Color: yellow, green, red



TP106-Bow sight light

- Lights up your sight ping
- 3/8-32 thread
- Fits APEX, COBRA, COPPER JOHN, PSE, TROPHY RIDGE AND TRUGLO sights and more



TP110-Bow stand

- Lightweight, compact, folding kick stand, for all bows



TP111-Allen key combo



TP113-Target paper



TP103-Relplacement brush

- Replacement brushes for arrow rest TP811, TP812
- With screw



TP104-Compound bow D-loop

- 100 foot
- Stiff easy to tie and burns perfectly
- Super durable bow string release d loop material



TP105-Relplacement brush

- Replacement whisker brush for TP813 arrow rest



TP114-Replacement brush



TP115-Arrow Puller



TP123-Arrow rest rope fixed buckle



TP107-Hunter armguard

- 7.5" nylon guard with buckles
- Protects forearm (RH/LH)
- Quick Buckles adjustment system



TP108-Bow string wax

- Bow String Wax protect bow string
- 0.5 oz



TP109-Bow dampener kits

- 2pcs limb damper
- 1pcs string stop damper
- 4pcs bowstring damper
- Color: Black/Red/Blue



TP141-Cable slide



TP142-Cable slide



TP140-Roller cable slide



TP145-D-Loop



TP146-Nock Set

TF8000-Bow Fishing Combo



TP159-Archery Training Device

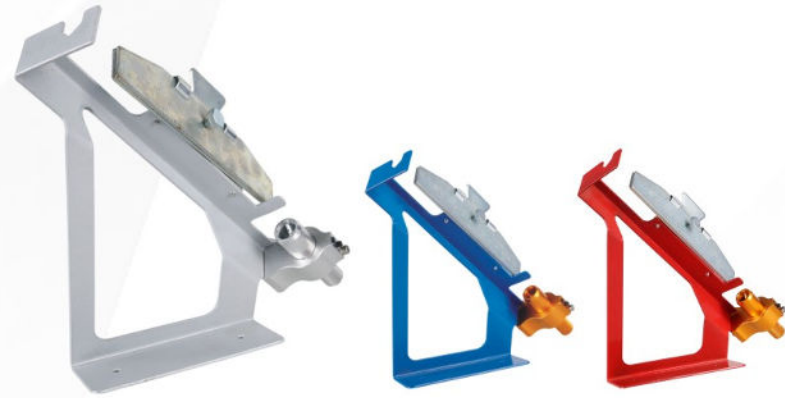

TP165-ARROW FLETCHING JIG



- 1pcs bowfishing arrow rest
- 1pcs bowfishing reel seat
- 1pcs bowfishing reel, with 30 meter bowfishing line
- 3pcs bowfishing arrow



TF801-Bowfishing broadhead



TF802-Bowfishing arrow



TF804-Bowfishing reel



Black ▲

TF803-Bowfishing reel seat



Blue ▲



Silver ▲



TF809-Bowfishing reel



TF805-Bowfishing arrow rest



TF825-Bowfishing arrow rest



ARROWS



Fiberglass arrows

- OD (MM): 8.0 • WEIGHT (G): 35.4
- ID (MM): 6.2 • Length (INCH): 30
- SPINE: 500



Carbon mix arrow

- OD (MM): 7.8 • WEIGHT (G): 32
- ID (MM): 6.2 • Length (INCH): 30
- SPINE: 550-600



Carbon Arrow

- OD (MM): 7.4 • WEIGHT (G): 24.8
- ID (MM): 6.2 • Length (INCH): 30
- SPINE: 350



Pure carbon shafts & camo

- OD (MM): 7.6 • WEIGHT(G): 26.3
- ID (MM): 6.2 • Length(INCH): 30
- SPINE: 350



Pure carbon shafts & PAITING

- OD (MM): 7.4 • WEIGHT (G): 23.6
- ID (MM): 6.2 • Length (INCH): 30
- SPINE: 350



Aluminum arrow with protect sleeve

- OD (MM): 7.6 • WEIGHT (G): 35
- ID (MM): 6.5 • Length (INCH): 30
- SPINE: 500

Carbon Arrow



ITEM NO.	SHAFT MATERIAL	O.D. (mm)	I.D. (mm)	SHAFT LENGTH	FILED POINT	ARROW NOCK	ARROW VANES	TOTAL LENGTH	SPINE	WEIGHT (g)	DRAW WEIGHT	BOW SELECT
TPTJ-100B	Pure Carbon	7.51	6.22	30"	Replaceable	Plug Nock	2" Plastic	31.50"	340	24	75 LBS	Compound /Recurve
TPTJ-100S	Pure Carbon	7.51	6.22	30"	Replaceable	Plug Nock	3"	31.50"	340	24	75 LBS	Compound /Recurve
TPTJ-80HB	Carbon	7.60	6.22	30"	Replaceable	Plug Nock	2" Plastic	31.50"	340	29	75 LBS	Compound /Recurve
TPTJ-80HB-MC	Carbon Camo	7.60	6.22	30"	Replaceable	Plug Nock	2" Plastic	31.50"	340	29	75 LBS	Compound /Recurve
TPTJ-80HS	Carbon	7.60	6.22	30"	Replaceable	Plug Nock	3"	31.50"	340	29	75 LBS	Compound /Recurve
TPTJ-80HS-MC	Carbon Camo	7.60	6.22	30"	Replaceable	Plug Nock	3"	31.50"	340	29	75 LBS	Compound /Recurve
TPTJ-78HS	Carbon Mix	7.80	6.22	30"	Replaceable	Plug Nock	3"	31.50"	500	34	60 LBS	Compound /Recurve
TPTJ-78BS	Carbon Mix	7.80	6.22	30"	Replaceable	Plug Nock	2" Plastic	31.50"	500	34	60 LBS	Compound /Recurve
TPTJ-70HS	Carbon Mix	7.00	5.18	30"	Plug Head	Aluminum Nail +Plug Nock	3"	31.50"	700	31	50 LBS	Compound /Recurve
TPTJ-70BS	Carbon Mix	7.00	5.18	30"	Replaceable	Aluminum Nail +Plug Nock	2" Plastic	31.50"	700	32	50 LBS	Compound /Recurve
TPTJ-60HS	Carbon Mix	6.00	4.20	31"	Plug Head	Aluminum Nail +Plug Nock	2" Plastic	32.28"	1000	29	40 LBS	Recurve
TPTJ-42BS	Pure Carbon	5.60	4.20	30"	Plug Head	Plug Nock	2" Plastic	31.50"	700	19	40 LBS	Recurve
TPTJ-42HS	Carbon	5.90	4.20	30"	Plug Head	Plug Nock	2" Plastic	31.50"	700	24	40 LBS	Recurve
TPTJ-100B-GREEN	Pure Carbon	7.51	6.22	30"	Replaceable	Plug Nock	2" Plastic	31.50"	340	26	90 LBS	Compound /Recurve
TPTJ-80HB-BLUE	Carbon	7.60	6.22	30"	Replaceable	Plug Nock	2" Plastic	31.50"	340	29	75 LBS	Compound /Recurve
TPTJ-78BS-RED	Carbon Mix	7.80	6.22	30"	Replaceable	Plug Nock	2" Plastic	31.50"	500	34	60 LBS	Compound /Recurve
TPTJ-70BS-ORANGE	Carbon Mix	7.00	5.18	30"	Replaceable	Aluminum Nail +Plug Nock	2" Plastic	31.50"	700	32	50 LBS	Compound /Recurve

Fiberglass Arrow

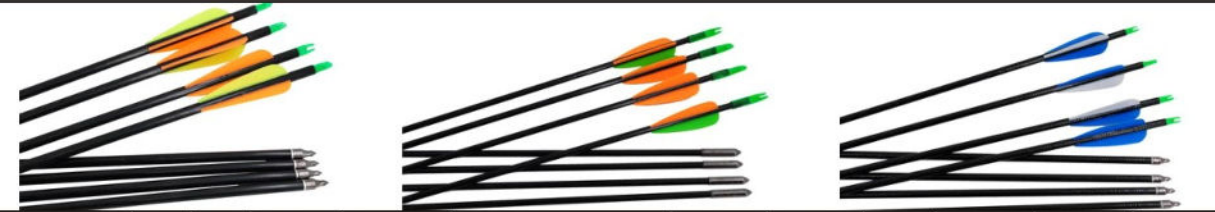

ITEM NO.	SHAFT MATERIAL	O.D. (mm)	I.D. (mm)	SHAFT LENGTH	FILED POINT	ARROW NOCK	ARROW VANES	TOTAL LENGTH	SPINE	WEIGHT (g)	DRAW WEIGHT	BOW SELECT
TPBJ-7028	Fiberglass	7.00	5.00	28"	Coat Head	Coat Nock	2.5"	28.74"	700	30	30 LBS	Children Bow
TPBJ-8001	Fiberglass	8.00	6.00	30"/32"	Replaceable	Protect Sleeve +Plug Nock	3"	31.50"	500	42	50 LBS	Compound /Recurve
TPBJ-8002	Fiberglass	8.00	6.00	30"/32"	Coat Head	Protect Sleeve +Plug Nock	3"	31.50"	500	42	50 LBS	Compound /Recurve
TPBJ-8003	Fiberglass	8.00	6.00	30"/32"	Plug Head	Protect Sleeve +Plug Nock	3"	31.10"	500	42	50 LBS	Compound /Recurve
TPBJ-7001	Fiberglass	7.00	5.00	30"	Coat Head	Coat Nock	3"	31.50"	700	37	40 LBS	Recurve
TPBJ-6001	Fiberglass	6.00	4.00	30"	Coat Head	Coat Nock	3"	31.50"	1200	29	30 LBS	Recurve
TPBJ-80CL	Weave fiberglass	8.00	6.22	30"	Replaceable	Plug Nock	3"	31.50"	500	35	50 LBS	Compound /Recurve

Aluminum Arrow



ITEM NO.	SHAFT MATERIAL	O.D. (mm)	I.D. (mm)	SHAFT LENGTH	FILED POINT	ARROW NOCK	ARROW VANES	TOTAL LENGTH	SPINE	WEIGHT (g)	DRAW WEIGHT	BOW SELECT
TPLJ-2219	7075-T6	8.80	7.70	30"	Replaceable	Plug Nock	4"	31.50"	300	38	80 LBS	Compound
TPLJ-2219MC	7075-T6 Camo	8.80	7.70	30"	Replaceable	Plug Nock	4"	31.50"	300	38	80 LBS	Compound
TPLJ-8001	7075-T6	8.00	7.70	30"	Replaceable	Plug Nock	3"	31.50"	400	42	55 LBS	Compound /Recurve
TPLJ-1916	7075-T6	7.60	6.50	30"	Replaceable	Plug Nock	3"	31.50"	500	35	50 LBS	Compound /Recurve
TPLJ-1916-RED	7075-T6	7.60	6.50	30"	Replaceable	Plug Nock	3"	31.50"	500	35	50 LBS	Compound /Recurve
TPLJ-1916-BLUE	7075-T6	7.60	6.50	30"	Replaceable	Plug Nock	3"	31.50"	500	35	50 LBS	Compound /Recurve
TPLJ-1916-GOLDEN	7075-T6	7.60	6.50	30"	Replaceable	Plug Nock	3"	31.50"	500	35	50 LBS	Compound /Recurve
TPLJ-1916LD	7075-T6	7.60	6.50	30"	Replaceable	Aluminum Nail +Plug Nock	3"	31.50"	500	35	50 LBS	Compound /Recurve
TPLJ-1816	7075-T6	7.14	6.32	31"	Plug Head	Aluminum Nail +Plug Nock	3"	32.28"	650	24	40 LBS	Recurve

Broadheads



TF801

Bowfishing broadheads



TF806

Bowfishing broadheads



TF807

Bowfishing broadheads



TP211

100gr,3 fixed blades, 6pcs/pack



TP211-125

125gr,3 fixed blades, 6pcs/pack



TP237

100gr,2 blades expandable, 6pcs/pack



TP238

100gr,3 fixed blades, 6pcs/pack



TP239

100gr,4 fixed blades, 6pcs/pack



TP240

100gr,3 blades expandable, 3pcs/pack



TP241

100gr,4 fixed blades, 6pcs/pack



TP212

100gr, 3 fixed blades, laser welded, 6pcs/pack



TP213

100gr, 2 blades expandable, 6pcs/pack



TP215

100gr,3 blades expandable, 3pcs/pack



TP216

100gr,3 fixed blades, 6pcs/pack



TP219

For wooden arrow,2 fixed blades, 6pcs/pack



TP242

100gr,3 fixed blades, 6pcs/pack



TP243

100gr,6pcs/pack



TP244

100gr,6pcs/pack



TP245

100gr,3 blades expandable, 3pcs/pack



TP246

Foam broadheads



TP221

100gr,4 fixed blades,solid steel, 3pcs/pack



TP224

100gr,2 blades expandable, 6pcs/pack



TP225-100

100gr,2 fixed blades, 3pcs/pack



TP225-125

125gr,2 fixed blades, 3pcs/pack



TP226

100gr,2 blades expandable, 5pcs/pack



TP247

100gr,6pcs/pack



TP248

100gr,2 fixed blades,2 circle blades, 3pcs/pack



TP249

150gr,3 fixed blades,3pcs/pack



TP250

100gr,2 fixed blades, 6pcs/pack



TP251

100gr,3 blades expandable, 3pcs/pack



TP227

100gr,2 blades expandable, 5pcs/pack



TP228

100gr,2 blades expandable, 6pcs/pack



TP229

100gr,2 blades expandable, 6pcs/pack



TP230

100gr,4 fixed blades, 3pcs/pack



TP231

100gr,4 fixed blades, 3pcs/pack



TP252

100gr,4 fixed blades, 3pcs/pack



TP253

100gr,3 fixed blades, MIM, 3pcs/pack



TP254

100gr,3 fixed blades,3pcs/pack



TP260-100

100gr,Target Field Point, 12pcs/pack



TP260-120

120gr,Target Field Point, 12pcs/pack



TP232

100gr,6 fixed blades, 3pcs/pack



TP233

100gr,6pcs/pack



TP234

100gr,6pcs/pack



TP235

100gr,6 fixed blades, 3pcs/pack



TP236

100gr, 2 blades expandable, 1 fixed blade,6pcs/pack



TP260-150

150gr,Target Field Point, 12pcs/pack



TP260-200

200gr,Target Field Point, 12pcs/pack



TP270

120gr,Tungsten Target Point, 12pcs/pack



Recurve Bow Series



AERODYN
TOP-X
CROSS CARBON/FOAM

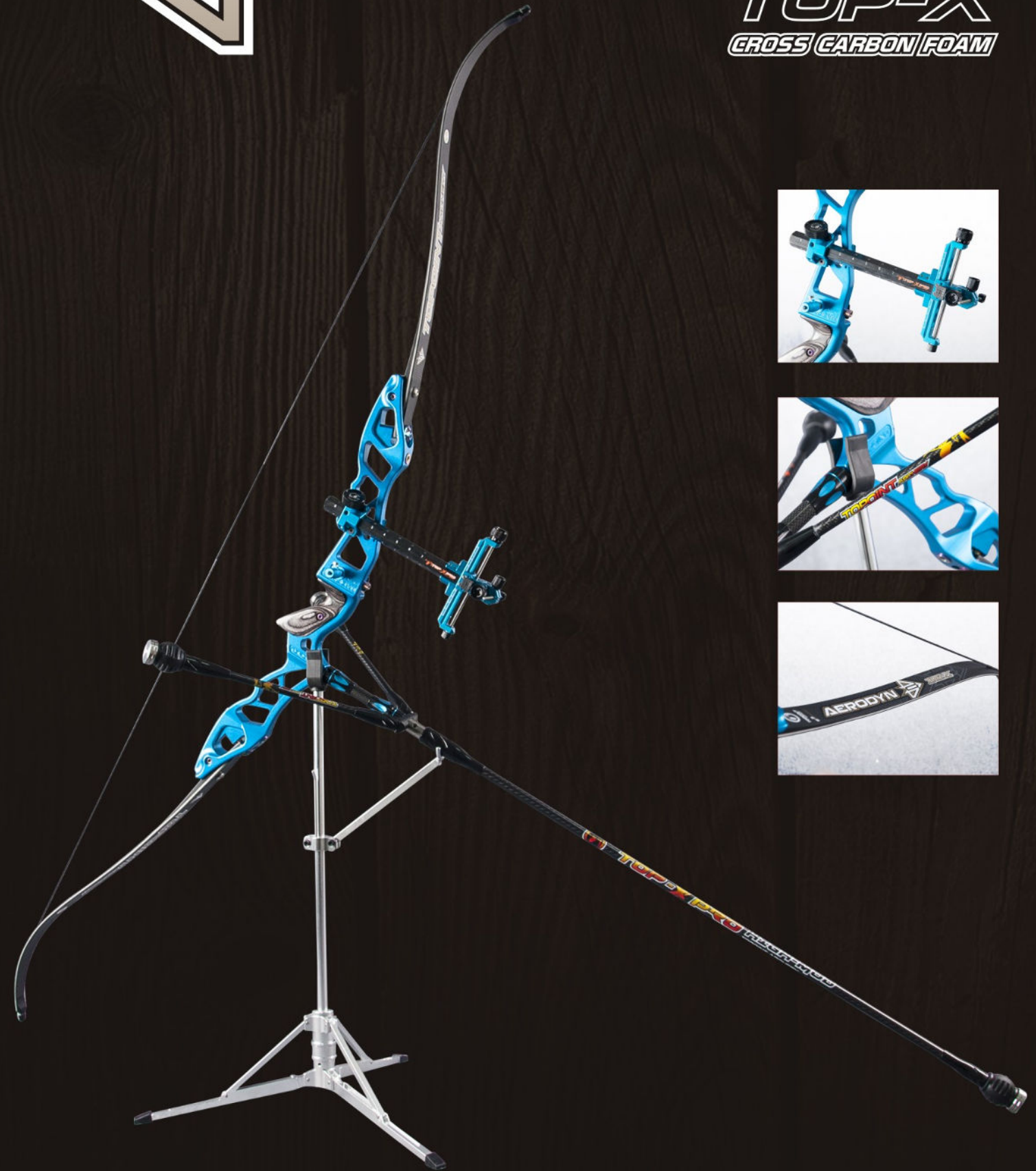

AERODYN

Target Recurve Bow Riser **Right Hand /Left Hand Available**

25"



Red Purple Blue Turquoise Green Orange Smoke Black

SPECIFICATIONS

- PHYSICAL WEIGHT >> 2.81Lbs
- MATERIAL >> Aluminum CNC 7075-T651
- BRACE HEIGHT >> 21-22.5CM
- LENGTH >> 25"(FITS FOR A 66" 68" OR 70" BOW)
- PROCESSING >> CNC
- POCKET TYPE >> ILF
- TYPE >> RH/LH
- GRIP >> Wood



Aluminum CNC 7075-T651



Slow production



Special unique designed wooden grip

AERODYN TOP-X CROSS CARBON FOAM

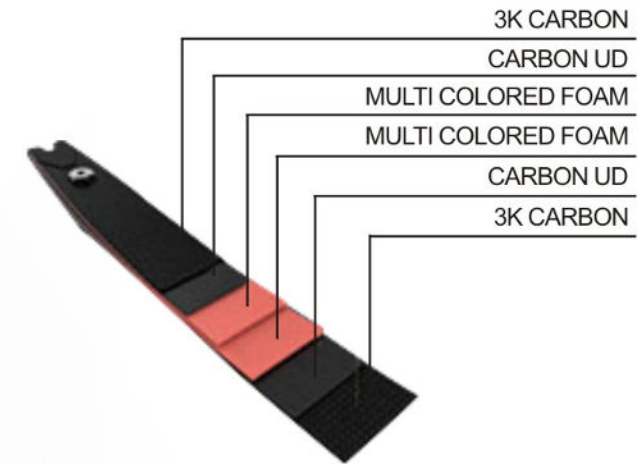

AERODYN CARBON FOAM LIMBS

Nano-carbon technology, with foam core limbs, offers extreme stability and less vibration. The superior limb geometry creates increased energy and exceptional speed.

RECURVE BOW LIMBS // INCREASING BY 2LBS



RISER	SHORT	MEDIUM	LONG
FITS 23" ILF RISER	64"-28 TO 52LBS	66"-28 TO 52LBS	68"-28 TO 52LBS
FITS 25" ILF RISER	66"-26 TO 50LBS	68"-26 TO 50LBS	70"-26 TO 50LBS





SPECIFICATIONS

- PROCESSING >> CNC
- PHYSICAL WEIGHT >> 1.96Lbs
- MATERIAL >> Aluminum CNC Machining
- POCKET TYPE >> ILF
- BRACE HEIGHT >> 19-20.5CM
- LENGTH OF RISER >> 21"
- LENGTH >> 21" (FITS FOR A 62" 64" OR 66" BOW)
- FINISH >> Anodized / Camo
- TYPE >> RH/LH
- GRIP >> Plastic



Aluminum CNC Machining



Limb Alignment



Plastic grip



Red Turquoise Blue Purple Orange Green Smoke Black



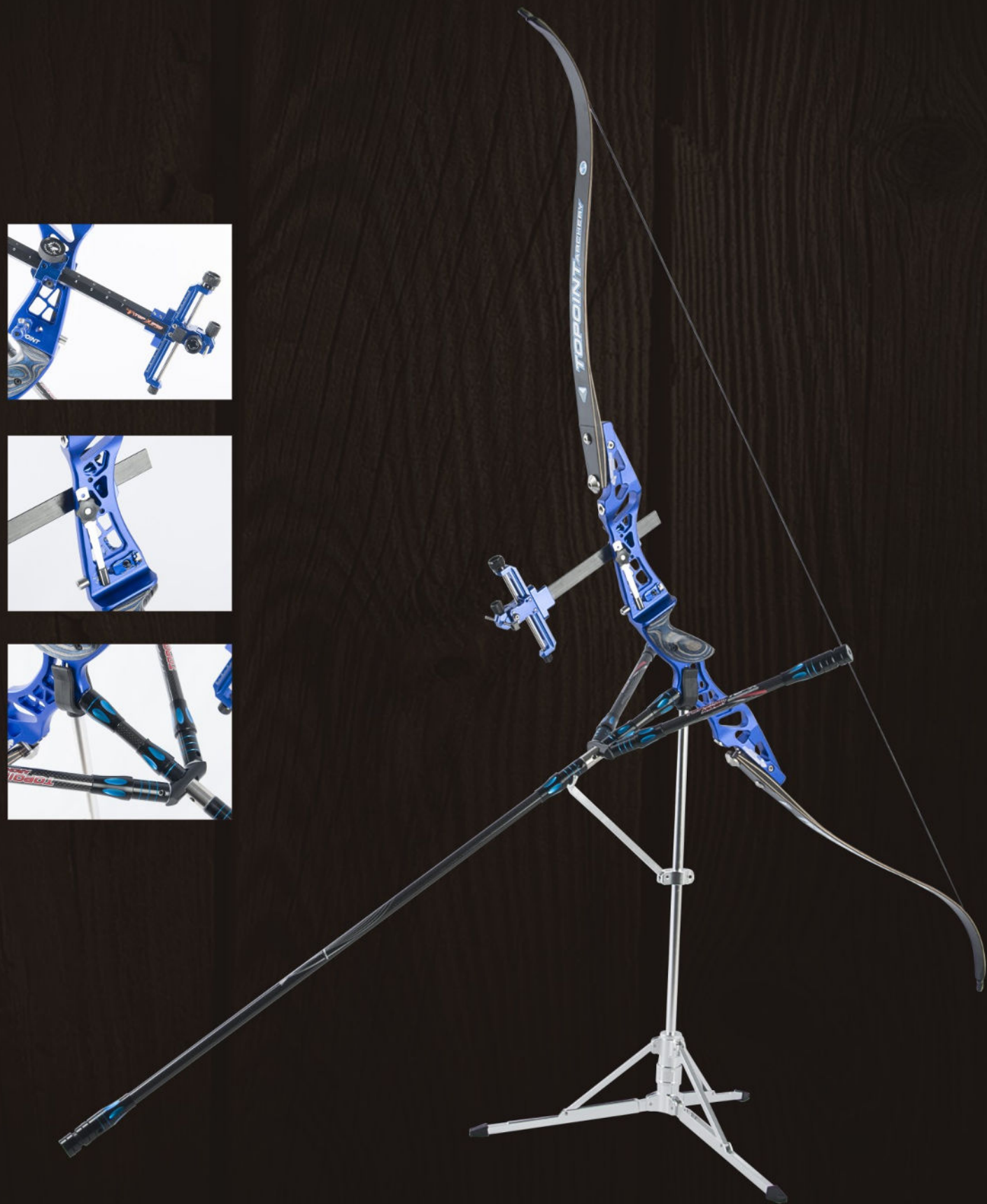

SPECIFICATIONS

- PROCESSING >> CNC
- PHYSICAL WEIGHT >> 2.2 Lbs
- MATERIAL >> Aluminum CNC Machining
- POCKET TYPE >> ILF
- BRACE HEIGHT >> 20-21.5CM
- LENGTH OF RISER >> 23"
- LENGTH >> 21" (FITS FOR A 64" 66" OR 68" BOW)
- FINISH >> Anodized / Camo
- TYPE >> RH/LH
- GRIP >> Wood



Aluminum CNC Machining



Limb Alignment



Special unique designed wooden grip



Red Turquoise Blue Purple Orange Green Smoke Black



UNISON²⁵ TOPOINT

Right Hand /Left Hand Available

SPECIFICATIONS

- PROCESSING >> CNC
- PHYSICAL WEIGHT >> 2.54Lbs
- MATERIAL >> Aluminum CNC Machining
- POCKET TYPE >> ILF
- BRACE HEIGHT >> 21-22.5CM
- LENGTH OF RISER >> 25"
- LENGTH >> 21" (FITS FOR A 66" 68" OR 70" BOW)
- FINISH >> Anodized / Camo
- TYPE >> RH/LH
- GRIP >> Wood



Aluminum CNC Machining

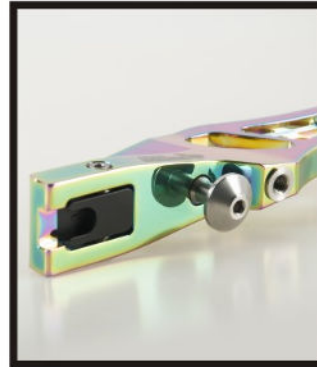

Limb Alignment



Special unique designed wooden grip



Red Turquoise Blue Purple Orange Green Smoke Black Ghost Tactical Spectra

UNISON TOP-X^{E3} TECHNOLOGY

CROSS CARBON FOAM EXPERTISE ENERGY EMOTION

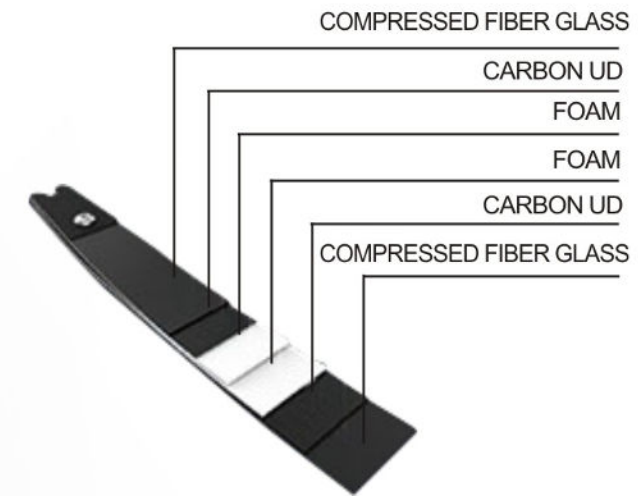

UNISON CARBON FOAM LIMBS

Nano carbon limbs with MCF (Multi Compressed Fiber) technology, which results in enhanced speed. These limbs have outer carbon laminates surrounding a foam core.

RECURVE BOW LIMBS // INCREASING BY 2LBS



RISER	SHORT	MEDIUM	LONG
FITS 23" ILF RISER	64"-24 TO 50LBS	66"-24 TO 50LBS	68"-24 TO 50LBS
FITS 25" ILF RISER	66"-22 TO 48LBS	68"-22 TO 48LBS	70"-22 TO 48LBS



ENDEAVOR

Recurve Bow Riser // Right Hand /Left Hand Available



Black White Blue Red Purple Green Ghost Tactical

SPECIFICATIONS

- PHYSICAL WEIGHT >> 2.36Lbs
- RISER >> Magnesium Aluminum Alloy
- POCKET TYPE >> ILF
- BRACE HEIGHT >> 21-22.5CM
- LENGTH OF RISER >> 25"
- LENGTH >> 25" (FITS FOR A 66" 68" OR 70" BOW)
- FINISH >> Colorful Paint
- TYPE >> RH/LH
- GRIP >> Plastic



Grip



Limb Alignment



Magnesium Riser



ENDEAVOR

E³ TECHNOLOGY
EXPERTISE
ENERGY
EMOTION

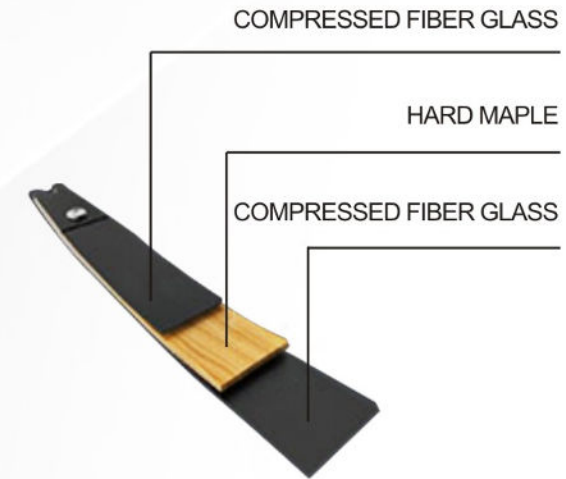

ENDEAVOR GLASS WOOD LIMBS

Cost-effective limbs made of glass laminates surrounding a hard maple core. The limbs have been tested for straightness to insure there's no twisting through the draw cycle.

RECURVE BOW LIMBS // INCREASING BY 2LBS



RISER	SHORT	MEDIUM	LONG
FITS 23" ILF RISER	64"-18 TO 46LBS	66"-20 TO 46LBS	68"-20 TO 46LBS
FITS 25" ILF RISER	66"-16 TO 44LBS	68"-18 TO 44LBS	70"-18 TO 44LBS





ENDEAVOR TOPOINT

Flawless Coating
Showy color form painting
Perfect centroidal balance
Standard ILF compatible
PROCESSING >> DIE-CASING
Right Hand /Left Hand Available



68" (String Type: 8910(BCY), 12 strands)



Grip



Limb Alignment



Clicker extension

SPECIFICATIONS

- PHYSICAL WEIGHT >> 2.36Lbs
- RISER >> Magnesium Aluminum Alloy
- POCKET TYPE >> ILF
- BRACE HEIGHT >> 21-22.5CM
- LENGTH OF RISER >> 25"
- Bow Length(riser and limbs fitting) >> 68"
- FINISH >> Colorful Paint
- TYPE >> RH/LH
- GRIP >> Plastic



TOPOINT ENDEAVOR PACKING LIST



- | | |
|-------------------------|-------------------------------|
| 1. Manual x1 | 6. Riser x1 |
| 2. Stringx1 | 7. Limb x2 |
| 3. Clicker Extension x1 | 8. Recurve Bow Riser Cover x1 |
| 4. Screws x4 | 9. Recurve Bow Limb Cover x2 |
| 5. Allens x2 | |



TOPOINT ENDEAVOR PACKING LIST



- | | |
|--|--|
| 1. Riser x1 | 11. Finger Guard (TR138) x1 |
| 2. Limb x2 | 12. Allen Key Combo (TP111) x1 |
| 3. Bow Case (TR92)x1 | 13. Bow String Wax (TP108) x1 |
| 4. Arrows x12 | 14. Bow Stringer (TR122) x1 |
| 5. Long Rod Stabilizer (PR633-Main 30") x1 | 15. Nock Set (TP146) x4 |
| 6. Arrow Quiver (TP740) x1 | 16. Clicker Extension x1 Screws x4 Allens x2 |
| 7. Bow Sight (TR1007) x1 | 17. Target Paper (TP113) x3 |
| 8. Arm Guard (TR120) x1 | 18. Manual x1 |
| 9. Arrow Rest (TR818) x1 | 19. Recurve Bow Limb Cover x2 |
| 10. String (TR150) x1 | 20. Recurve Bow Riser Cover x1 |



Black ▲ Blue ▲ Green ▲ Purple ▲ Pink ▲ Yellow ▲ White ▲

RECURVE BOW R2 RIGHT HAND Only

- MASS WEIGHT >> 2.97Lbs
- RISER >> Magnesium Aluminum Alloy
- BOW LENGTH >> 68"
- LENGTH OF RISER >> 25"
- DRAW WEIGHT >> 18/ 20/ 24/ 28/ 30/32/ 36/ 38Lbs Select
- FINISH >> Colorful Paint
- COLOR >> Black/ White/ Yellow/ Blue/ Red/ Green/ Purple Select
- GRIP >> Plastic

TOPOINT R2 PACKING LIST



- | | |
|--------------------|------------------------|
| 1. Riser x1 | 9. Bow Sight x1 |
| 2. Limb x2 | 10. Arrow Rest x1 |
| 3. Arm Guard x1 | 11. Arrow Puller x1 |
| 4. String x1 | 12. Bow String Wax x1 |
| 5. Finger Guard x1 | 13. Allen Key Combo x1 |
| 6. Bow Stringer x1 | 14. Manual x1 |
| 7. Arrow x12 | 15. Screw |
| 8. Arrow Quiver x1 | |

HUNTING RECURVE BOW



SLITHER

Hunting Recurve Bow Riser // RIGHT HAND Only



Bronze Army green Black Smoke Tactical Ghost



Aluminum CNC Machining



Finish>>Anodized/Camo



Limb Alignment

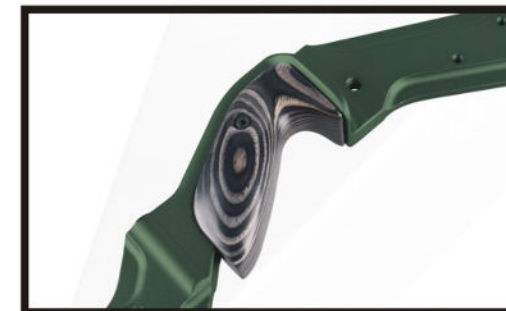

Special unique designed wooden grip

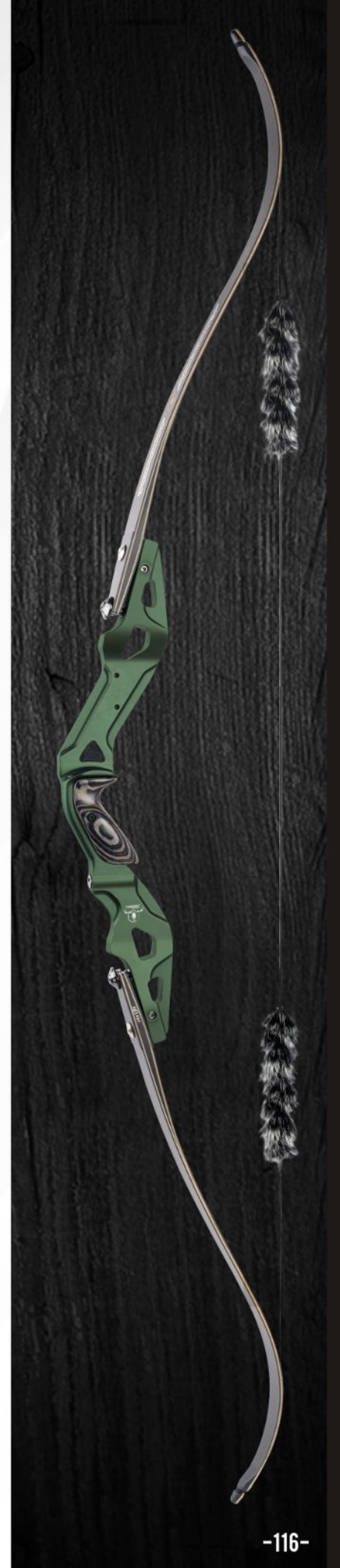



SLITHER

MODEL	SLITHER 17"	SLITHER 19"	SLITHER 21"
			
PHYSICAL WEIGHT	2.18Lbs	2.42Lbs	2.57Lbs
PROCESSING	CNC	CNC	CNC
MATERIAL	Aluminum CNC Machining	Aluminum CNC Machining	Aluminum CNC Machining
POCKET TYPE	ILF	ILF	ILF
BRACE HEIGHT	19-21CM	20-22CM	21-23CM
LENGTH OF RESER	17"	19"	21"
LENGTH	17"(FITS FOR A 58"60" OR 62" BOW)	19"(FITS FOR A 60"62" OR 64" BOW)	21"(FITS FOR A 62"64" OR 66" BOW)
FINISH	Anodized / Camo	Anodized / Camo	Anodized / Camo
TYPE	RH	RH	RH
GRIP	Wood	Wood	Wood

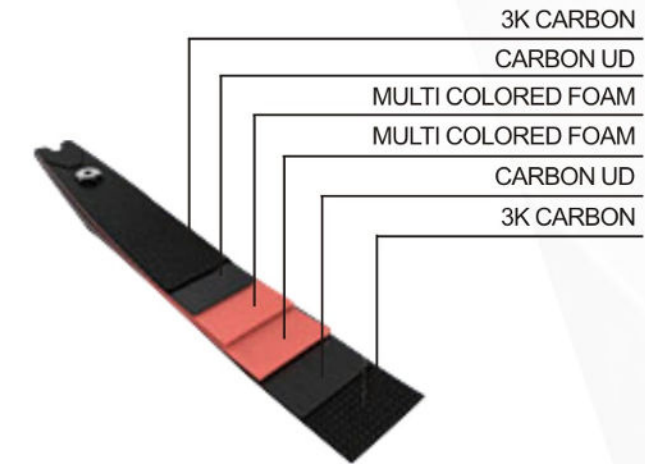

SLITHER CARBON FOAM LIMBS

Nano-carbon technology, with foam core limbs, offers extreme stability and less vibration. The superior limb geometry creates increased energy and exceptional speed.

RECURVE BOW LIMBS // INCREASING BY 2LBS



RISER	SHORT	MEDIUM	LONG
FITS 17" ILF RISER	58"-32 TO 57LBS	60"-32 TO 57LBS	62"-32 TO 57LBS
FITS 19" ILF RISER	60"-30 TO 55LBS	62"-30 TO 55LBS	64"-30 TO 55LBS
FITS 21" ILF RISER	62"-28 TO 53LBS	64"-28 TO 53LBS	66"-28 TO 53LBS

RECURVE BOW R3

RIGHT HAND Only

- MASS WEIGHT >> 3.02Lbs
- RISER >> Magnesium Aluminum Alloy
- BOW LENGTH >> 58"
- LENGTH OF RISER >> 18"
- DRAW WEIGHT >> 30/ 35/ 40/ 45/ 50Lbs Select
- FINISH >> Anodized/ Camo
- COLOR >> Black/ Ghost/ Camo/ Muddy Girl/ Snow Camo
- GRIP >> Aluminum



Ghost ▲ Camo ▲ Black ▲ Muddy-Girl ▲ Snow-Camo ▲

TOPOINT R3 PACKING LIST

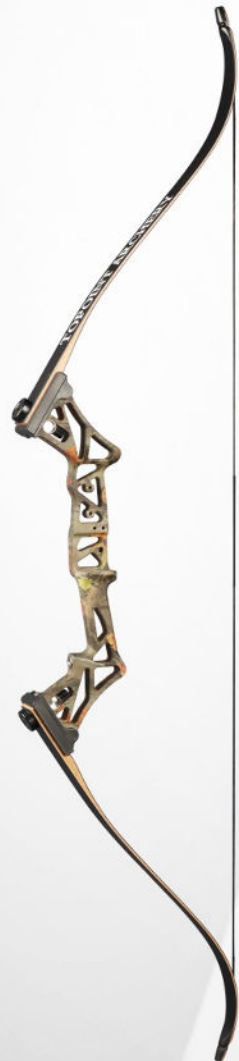

1. Riser x1
2. Limb x2
3. Arm Guard x1
4. String x1
5. Finger Guard x1
6. Bow Stabilizer x1
7. Bow Stringer x1
8. Arrow Rest x1
9. Bow Sight x1
10. Arrow x12
11. Arrow Quiver x1
12. Arrow Puller x1
13. Bow String Wax x1
14. Allen Key Combo x1
15. Screw
16. Manual x1

48" ▶

54" ▶

62" ▶

WOODEN RECURVE BOW R7

RIGHT HAND Only

Mass weight	1.2Lbs/1.6Lbs/2.1Lbs
Bow Length/ Draw Weight	48" /16Lbs
	48" /20Lbs
	54" /20Lbs
	54" /24Lbs
	62" /28Lbs
62" /36Lbs	
Riser Material	Wooden



WOODEN RECURVE BOW R27

RIGHT HAND Only

- PHYSICAL WEIGHT >> 2.33Lbs
- MATERIAL >> Wood
- BOW LENGTH >> 62"
- LENGTH OF RISER >> 19"
- DRAW WEIGHT >> 25/ 30/ 35/ 40/ 45/ 50Lbs Select
- BRACE HEIGHT >> 19cm
- TYPE >> RH
- GRIP >> Wood



WOODEN RECURVE BOW R35

RIGHT HAND Only

- PHYSICAL WEIGHT >> 2.44Lbs
- MATERIAL >> Wood
- BOW LENGTH >> 60"
- LENGTH OF RISER >> 15"
- DRAW WEIGHT >> 25/ 30/ 35/ 40/ 45/ 50Lbs Select
- BRACE HEIGHT >> 16.5cm
- TYPE >> RH
- GRIP >> Wood

TOPOINT R27 PACKING LIST



- | | | |
|--------------------|--------------------|---------------------|
| 1. Riser x1 | 6. Bow Sight x1 | 11. Arrow Puller x1 |
| 2. Limb x2 | 7. Arrow Quiver x1 | 12. Target Paper x3 |
| 3. Arm Guard x1 | 8. Finger Guard x1 | 13. Arrow x12 |
| 4. String x1 | 9. Arrow Rest x1 | 14. Bow Case x 1 |
| 5. Bow Stringer x1 | 10. Nock Set x5 | |

TOPOINT R35 PACKING LIST



- | | | |
|--------------------|---------------------|---------------------|
| 1. Riser x1 | 6. Arrow Rest x1 | 11. Arrow Puller x1 |
| 2. Limb x2 | 7. Arrow Quiver x1 | 12. Arrow x12 |
| 3. Arm Guard x1 | 8. Finger Guard x1 | 13. Bow Case x 1 |
| 4. String x1 | 9. Nock Set x5 | |
| 5. Bow Stringer x1 | 10. Target Paper x3 | |



WOODEN RECURVE BOW R36

RIGHT HAND Only

- PHYSICAL WEIGHT >> 2.6Lbs
- MATERIAL >> Wood
- POCKET TYPE >> ILF
- BOW LENGTH >> 60"
- LENGTH OF RISER >> 17"
- BRACE HEIGHT >> 19.5cm
- TYPE >> RH
- GRIP >> Wood



Bow Sights Series



TR1001 ▲

- High impact nylon construction
- Lightweight and durable
- Excellent intermediate archers
- Smooth micro windage adjustment
- Includes ring pin with dot
- Quick-detach bow mount
- Available in black only

- Precision machined aluminum components for both right and left hand shooters
- Super light and strong with absolute shot accuracy and designed for use on both recurve and compound bows
- Worm gear sight bar with etches markings
- Single sight pin with square sight pin aperture
- Detachable bracket
- Ultra-fine click adjustment for windage and elevation



TR1002 ▲



TR1005 ▲

- SCOPES RECURVE 8/32 WITHOUT LENS
- Color: Blue /Black /Red /Green /Purple /Orange /Smoke /Turquoise
- CNC Housing

- OD select :14mm, 13mm, 12mm, 11.5mm, 10.2mm & 9.5mm
- 0.019", Green Fiber
- RH/LH



TR1007 ▲

- Beginner recurve sight
- Full aluminum construction
- 6" extension
- Windage and elevation adjustment

- 8/32 Ring pin incl.
- Incl. spare copper glider
- Removable mounting block

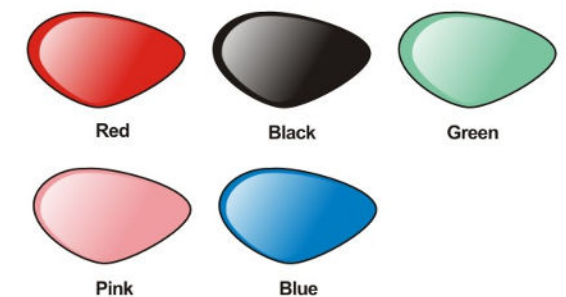

TR1003 ▲

- Recurve sight
- Carbon bracket
- Lightweight
- Quick release fast vertical adjustment
- 9" extension
- Windage and elevation adjustment
- RH and LH available
- Incl. Soft case
- 8/32 Ring pin incl.
- Available color : Black, Blue, Turquoise, Red, Smoke, Purple, Green, Orange

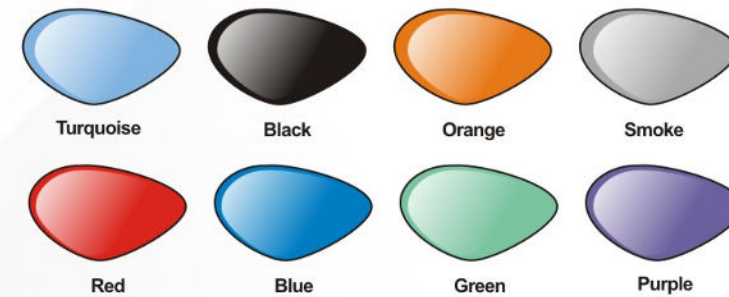



TR1009 ▲

- Recurve sight
- aluminum bracket
- Lightweight
- Quick release fast vertical adjustment
- 9" extension
- Windage and elevation adjustment
- Available in black only
- 8/32 Ring pin incl.



Arrow Rests



Right ▲

Left ▲

TR817 Series

- Precision rare-earth magnet and polished plate provide low friction and precise fit for smooth repeatable arrow launch
- Stainless steel construction for rust-free performance
- Low profile, universal fit for excellent clearance



TR829 Series

- Shelf Rests – Made of felt.
- The simplest of the traditional bow rests, and are widely favored by traditional bowhunters.
- Designed for archers who shoot their arrows off the shelf.

TR818 Series

- Precision CNC machined parts
- DLC (diamond-like carbon) coated offset support arm
- Dual adjust system - horizontal /vertical
- Dual magnets for consistent positioning
- Reversible for right or left hand



Red ▲



Black ▲



Green ▲



Golden ▲



Blue ▲



Purple ▲

TR830 Series

- With White Adhesive Backing Easy to install Just Stick it on to bow limbs
- Great for recurves and target bows Hold arrow stable and increase shooting accuracy
- Durable molded plastic construction
- Economical design , Self-adhesive back and finger to hold arrows



Red ▲



Black ▲

TR822 Series

- Fits for recurve bow
- Help to hold your arrow safety and securely
- Lightweight and more compact design
- Right and left hand



Green ▲



Golden ▲



Blue ▲



Purple ▲



Brown ▲



Smoke ▲

Archery Accessories



TR120-Arm Guard



TR121-Finger Guard



TR122-Bow Stringer



TR88-Bow Cases

- Size: 80*19*16cm
- Function: For recurve bow and accessories
- Material: Nylon
- Net weight: 745g



TR138-Finger Guard

- High grade cow leather, strong and durable
- It could prevent arm and fingers far from hurt when you shooting.
- It also ensures an effective shooting, avoiding the influence of your fingers on the arrows.
- Material: Cow leather + imitation metal plastic
- Size: XXS /XS /S /M /L /XL



TR131-Cushion Plunger

- Made from precision machined parts
- Threaded cylinder is made from high grade refined steel, springs from stainless harmonic steel, notching scale cylinder and nut from anodized aluminum
- Micro-click spring tension adjustment allows for exact settings time after time



TR132-Recurve Bow Klicke

- Designed to fit most recurve handles
- High-end engineered and manufactured
- Available in .025" blade thickness



TR133-Recurve Bow T Square

- Anodized aluminum construction
- Attach to bowstring with metal clips
- Etched reference marks
- Perfect for measuring nock and peep position or measuring tiller



TR134-Recurve Bow T Square



TR750-Arrow Quiver

- Lightweight design
- 3 tubes for easy access
- Multiple pockets
- Right handed
- Padded shoulder strap



TR136-65/44 Automatic Bow Stand

- Ultra-lightweight portable bow stand
- Anodized aluminum construction
- Legs fold out automatically with turning center cylinder
- Adjustable string keeper



TR150-String

- 68" (String Type: B55, 12 strands)



TR151-String

- 68" (String Type: 8910, 12 strands)



TR152-Limb Line Gauge

- A simple and effective precision tool for the tuning of bows

TR161 Bow Stand

- Size: 38cm(H)*43cm(W) After assembling
- Material: Plastic + Fiberglass + Aluminum
- Weight: 250g
- Suitable for holding recurve bow





Arm Guard-TR167

- Plastic skeletal arm guard with elastic straps and plastic clasps.
- Color: Red / Black / Blue / Turquoise / Green / Pink / Purple / Bronze / Orange



Finger Sling-TR168

- Size: 11.5cm/12.5cm/13.5cm/14.5cm



Arm Guard-TR169

- Soft Plastic arm guard with elastic straps and plastic clasps
- Color: Red / Black / Blue / Green / Pink / Purple / Orange

**High Hardness Steel : HRC46
Bolt Thread : M12x1.25**



TR-S1 ▲
Color: Black, Golden, Spectra



TR-S2 ▲
Color: Black, Golden, Spectra



TR-S3 ▲
Color: Black, Golden, Spectra



TR-S4 ▲
Color: Black, Golden, Spectra



TR-S5 ▲
Color: Black, Golden, Spectra



TR89-Bow Cases

- Smart clean design with plenty of functionality
- Individual storage for stabilizers, arrows, limbs and other accessories
- Backpack straps and carry handle make it easy to transport
- Includes riser & limb sleeves and arrow tube
- 27.5 x 13 x 5.5inch



TR92-Bow Cases

- Smart clean design with plenty of functionality
- Individual storage for stabilizers, arrows, limbs and other accessories
- Includes riser & limb sleeves and arrow tube
- Material: ABS
- Size:90 x 20 x 13cm

Camo Ball CAP TP10

- Velcro adjustment in back
- One size fits most
- 100% cotton



Camo 3-D Leafy suits TP20

- 100% Polyester
- Laser cutting
- 3-D Suit includes jacket, pants and head net
- Size: M/L/XL/XXL

